



HIPTI - High Performance Thermal Insulation
IEA/ECBCS Annex 39

Vacuum Insulation in the Building Sector

Systems and Applications

Institutions and Authors

FHBB – Switzerland

Armin Binz
André Moosmann
Gregor Steinke
Uwe Schonhardt
Franco Fregnan

EMPA - Switzerland

Hans Simmler
Samuel Brunner
Karim Ghazi
Reto Bundi

ZAE-Bayern - Germany

Ulrich Heinemann
Hubert Schwab

TU Delft - Netherlands

Hans Cauberg
Martin Tenpierik

KTH Stockholm - Sweden

Gudni Johannesson
Thomas Thorsell

Dr.Eicher+Pauli AG - Switzerland

Markus Erb (Operating Agent)
Beat Nussbaumer



Impressum

IEA/ECBCS Annex 39

The work presented here is a contribution to Annex 39 of IEA/ECBCS-Implementing Agreement.

Vacuum Insulation in the Building Sector

Systems and Applications

Institutions and Authors

FHBB – Switzerland

Armin Binz (Operating Agent Annex 39, Subtask B)
André Moosmann, Gregor Steinke, Uwe Schonhardt, Franco Fregnan

EMPA - Switzerland

Hans Simmler, Samuel Brunner, Karim Ghazi, Reto Bundi

ZAE-Bayern - Germany

Ulrich Heinemann, Hubert Schwab

TU Delft - Netherlands

Hans Cauberg, Martin Tenpierik

KTH Stockholm – Sweden

Gudni Johannesson, Thomas Thorsell

Dr.Eicher+Pauli AG - Switzerland

Markus Erb (Operating Agent Annex 39)
Beat Nussbaumer

Credits

This report represents the work of many people working on research, development and application of Vacuum Insulation Panels with great enthusiasm. It would not have been completed without them.

The team of authors are grateful to all planners, principals, firms and people who contributed with useful information to this research project. The responsible persons who helped us to get the information about the case reports, are named in those parts of the publication. It was the concept of this project, to analyse many cases. So at the end we had to renounce on publishing all the cases we could collect. Either they were doubles or not typical or not any more technically appropriate. Nevertheless they contributed to the learning process about VIP during this project.

We wish to thank particularly the members of the technical committee: Mr. St. Abegg (ZZWancor), Mr. B. Arnold (ZZWancor), Mr. G. Bründler (ZZWancor), Mr. J. Fehr (Schneider Dämmtechnik), Mr. Derrer (Schneider Dämmtechnik), Mr. H. Nikol.

In addition to the mentioned responsible persons in the case reports we thank for information and documents Mr. R. Derungs (Derungs Architekten), Mr Steffen (Jakob Hoehn + Partner).



Abstract

Vacuum insulation panels (VIP) were already developed some time ago for use in appliances such as refrigerators and deep-freezers. Their insulation performance is a factor of five to eight times better than that of conventional insulation. Used in buildings they enable thin, highly insulating constructions to be realized for walls, roofs and floors.

The introduction of such a novel material in the building trade, however, is hampered by many open questions and risks. Hence within the scope of a four-year research project, which was carried out within IEA/ECBCS Annex 39 'HiPTI – High Performance Thermal Insulation', an international research team investigated the fundamentals of vacuum insulation panels and the prerequisites, risks and optimal application of these materials in the building trade. The study was financed by the Federal Office of Energy of Switzerland. On the Swiss side, a working group vip-bau.ch consisted of the Institute of Energy at the FHBB, the EMPA and Dr. Eicher+Pauli AG. In close co-operation with VIP suppliers in Switzerland, Subtask A addressed fundamental questions in connection with the material, whereas Subtask B examined questions regarding the application of VIP in the building trade.

The present Final Report of Subtask B, illustrated with a wide selection of reports from practice, shows how the building trade deals with this new material today, the experience gained and the conclusions drawn there from. As well as presenting recommendations for the practical use of VIP, the report is also able to answer questions regarding the effective insulation values to be expected with today's VIP.



Content

ABSTRACT	I
1 SUMMARY	1
1.1 Properties of Vacuum Insulation Panels	1
1.2 VIP in practical use	2
1.3 Use of VIP – Recommendations	4
2 INTRODUCTION TO VIP FOR BUILDINGS	6
2.1 Development of insulation standards	6
2.2 Energy in buildings	6
2.3 Potential impact of VIP for building insulation	7
2.4 Vacuum Insulation today	7
3 VIP – A NEW MATERIAL FOR THE BUILDING INDUSTRY	8
3.1 Properties of VIP	8
3.2 Aging, durability and risk factors	8
3.3 Thermal bridge effects	10
3.3.1 Thermal bridging due to high barrier envelopes	10
3.3.2 Modelling the VIP for numerical calculations	13
3.3.3 An approximating model for calculating Ψ_{VIP} -values of aluminium foils	13
3.3.4 A method to reduce the thermal bridge effect at the edge of VIP	16
3.3.5 Influence of adjacent materials on thermal bridging	18
3.3.6 Thermal bridging due to façade panel edge constructions	19
3.4 Mechanical properties	22
3.5 Life Cycle Analysis	24
4 PRACTICE-REPORT	27
4.1 Floor and ceiling insulation – Attachment to a single-family house Zug/Switzerland	27



4.2	Interior and dormer window insulation – Refurbishment of property Zürich/Switzerland	32
4.3	Terrace insulation – Multifamily houses Kerzers/Switzerland	37
4.4	Floor insulation in a cold and deep-freeze room – Conversion of a shop Winterthur/Switzerland	40
4.5	Non-load bearing wall sandwich elements – Single-family house Landschlacht/Switzerland	44
4.6	Parapet insulation in window element Apartment conversion in a multifamily house Basel/Switzerland	49
4.7	Façade insulation with prefabricated panels – Terraced houses Binningen/Switzerland	52
4.8	Façade insulation – Renovation of a semi-detached house Nuernberg/Germany	53
4.9	Insulation of outside walls, roof and door – A new semi-detached wooden house Munich/Germany	56
4.10	Insulation of the building envelope – Complete renewal of a terraced house Munich/Germany	59
4.11	Insulation of a wall heating system – Renovation of a former church Wernfeld/Germany	63
4.12	Jamb-crossbar construction – Extension of the Hospital Erlenbach/Germany	65
4.13	Integrated façade element with radiator – Test façade ZAE Bayern Wuerzburg/Germany	68
4.14	Insulated prefabricated concrete elements – Office building with an apartment Ravensburg/Germany	70
4.15	Façade insulation – Passive house Bersenbrueck/Germany	72
4.16	Façade insulation with polystyrene-lined VIP – Terraced house Trier/Germany	73
4.17	Façade insulation – Refurbishment of an apartment and office block Munich/Germany	74
4.18	Floor insulation – Renovation of the Allgäu Energy and Environment Centre Kempten/Germany	75



4.19	Floor insulation – Renovation of the historic court house Schaffhausen/Switzerland	77
4.20	Renovation with insulation under underfloor heating Gemuenden/Germany	78
5	USE OF VIP – RECOMMENDATIONS	80
5.1	Overall construction domain	80
5.1.1	Information / Consulting	80
5.1.2	Edge effect	81
5.1.3	Detail processing	81
5.1.4	Water vapour diffusion	81
5.1.5	Replaceability of the VIP	81
5.1.6	Handling of VIP	82
5.2	VIP on the construction site	82
5.2.1	General recommendations	82
5.2.2	Outer walls with interior insulation	83
5.2.3	Terrace insulation	85
5.3	VIP in Prefabricated Components	87
5.3.1	General recommendations	87
5.3.2	Prefabricated wood construction system	92
5.3.3	Dormer Window	94
5.3.4	Door panels	96
5.3.5	Low temperature floor and wall heating systems	98
6	ECONOMIC ASPECTS	104
6.1	Costs	104
6.2	Economic benefits	105
6.2.1	Savings in building land	105
6.2.2	Maximization of usable area	106
7	ANNEX 39 - OUTLOOK	107
8	SUPPLIER ADDRESSES	109
	REFERENCES	110



1 Summary

Vacuum insulation panels (VIP) were already developed some time ago for use in appliances such as refrigerators and deep-freezers. Their insulation performance is a factor of five to eight times better than that of conventional insulation. They enable thin, highly insulating constructions to be realized for walls, roofs and floors. The introduction of such a novel material in the building sector, however, is accompanied by many open questions and risks.

In the time period 2002-2005 an international research team worked on the topic of vacuum insulation for buildings. The research was done within IEA/ECBCS Annex 39 'HiPTI – High Performance Thermal Insulation'. Whereas Subtask A dealt with basic questions of vacuum insulation, Subtask B was focussed on practical aspects of the application of vacuum insulation in the building sector.

The core part of the final report of Subtask B consists of practice reports, showing actual examples where vacuum insulation panels (VIP) have been used, and discussing special issues and open questions. A wide range of built examples, all using VIP, such as floor and ceiling constructions, terrace insulation, non-loadbearing sandwich elements, parapet insulation, prefabricated façade elements etc. form a rich basis of experience for interested planners and experts as well as manufacturers in search of new products with integrated VIP. Furthermore, the report states the actual knowledge on reliability, thermal bridge effect of the panel envelopes, i.e. the resulting thermal resistance of VIP, and recommended constructions with VIP. The results of Subtask B make clear that VIP have become a feasible and important means for energy efficient building.

VIP are significantly more expensive than conventional insulation materials. They will not displace the latter from the market, but will complement them in a realistic manner. The present price situation, however, is still dominated by the typical dynamics of the product introduction phase. Furthermore, the products themselves are still being developed, continually improved and they tend to become cheaper. Their extra price is in many cases justified by significantly increased benefits. The latter are mostly connected with space saving: in some cases satisfactory insulation may not be possible at all with normal materials, in others useful area may be able to be gained or conserved owing to the lower thickness of vacuum insulation.

1.1 Properties of Vacuum Insulation Panels

The thermal conductivity of a well evacuated dry VIP with a fumed silica core is typically about $0.004 \text{ W/(m}\cdot\text{K)}$ after production, measured in the centre of a large panel. The mean thermal conductivity of an insulation layer consisting of VIP is increased by thermal bridges as a result of the panel edges with aluminized films. The effects of these thermal bridges are different depending on the laminate type, panel thickness and adjacent materials.

In the course of its life in a building construction, even a well produced VIP panel will take up small amounts of air through the welding seams and pinholes in the laminate. This raises the internal pressure and above a certain value, the thermal resistance is lowered.



Within the project 'HiPTI – High Performance Thermal Insulation' of IEA/ECBCS Annex 39, numerous studies were conducted on the thermal bridging and aging effects. During the course of the research project, the quality of the panels and particularly the laminates has increased. The results of these studies led to the recommendation for the presently available VIP with metallized laminated films, normal panel size (e.g. 50 x 100 cm²) and correct installation in the construction, to add to the thermal conductivity an allowance of 0.001 to 0.002 W/(m·K) for thermal bridging and a further 0.001 to 0.002 W/(m·K) for aging (pressure rise). Depending on the panel size, thickness and placement, one calculates a thermal conductivity of 0.006 to 0.008 W/(m·K) for normal applications. This does not, of course, take into account constructive thermal bridges such as joints of the VIP insulation to walls and ceilings.

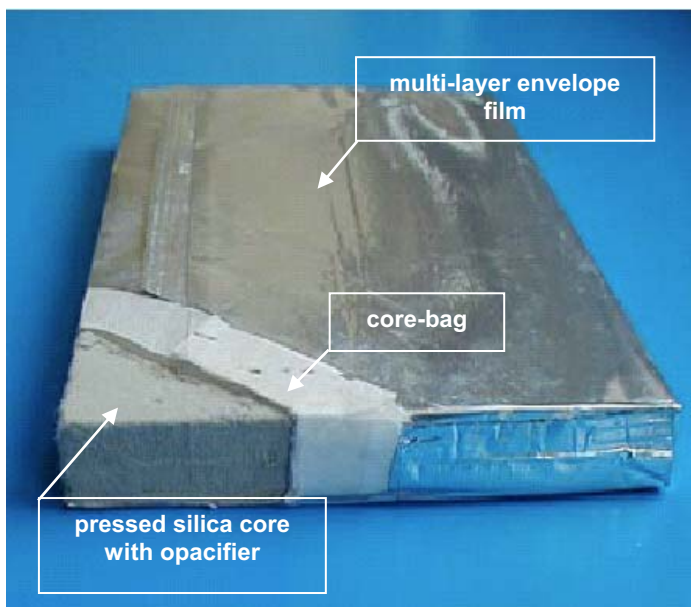
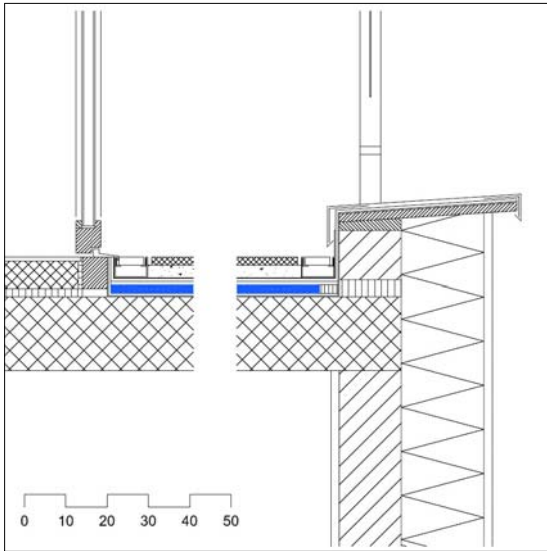

Figure 1: Components of a VIP. The core-bag provides mechanical stability for handling and protects the welding area from being polluted by core-powder (foto: va-Q-tec)

The use of new materials always poses the question of the long-term ecological effects. Within the scope of this project, a detailed life cycle analysis (LCA) was performed. The results show that the use of VIP in buildings leads to the same order of magnitude of environmental loading (or 'unloading') as for conventional insulation materials. Since the overall pollution by insulation during the building process is small, one can give the 'green light' to the use of VIP from an ecological standpoint.

1.2 VIP in practical use

VIP are today mainly installed directly in the construction on site. By far the commonest use is the insulation of flat roof terraces with VIP (Figure 2). This provides a simple method of avoiding unpleasantly high steps between the interior and the terrace.



Floor structure

garden tiles	20 mm
flint (draining)	30 mm
protection mat	
bitumen sealing	
rubber meal mat	
VIP	20 mm
PE foam mat	
vapour barrier	
concrete ceiling	200 mm

Figure 2: The installation of VIP in roof terraces enables a simple constructive solution for a stepless transition from interior to terrace

Although the processing of VIP under controlled conditions by specially trained personnel in a factory would be highly desirable, only a few prefabricated products and systems are available for the building sector (e.g. Figure 3). There are, however, signs that more component and system manufacturers are becoming involved in the development of such products. It can therefore be expected that in the foreseeable future, a wide selection of products such as floor heating systems, outside doors and wall elements with VIP will be offered.

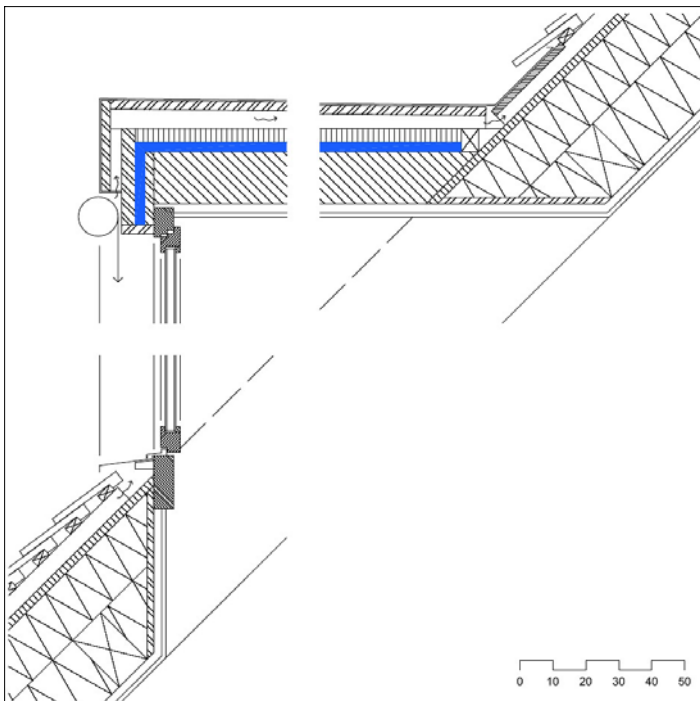

Roof structure

metal roofing	
polymer bitumen roof sheeting	
3-layer wooden board	27 mm
wooden laths	40-60 mm
protection mat	
soft grain board	40 mm
VIP	30 mm
ceiling (solid wood)	160 mm
vapour barrier	
wooden laths	27 mm
gypsum plaster board	12.5 mm

Figure 3: Section through a prefabricated dormer window for the renovation of an old building (Architect: Viridén + Partner, Zurich, Switzerland)



Apart from laminate-enveloped VIP, there are vacuum building panels from lambdasave GmbH (earlier Thyssen Vakuumtechnik AG) consisting of evacuated stainless steel cases, also with a core of fumed silica (Figure 4). These panels can be manufactured in large sizes (up to three by eight metres) and are extremely vacuum-tight and robust.

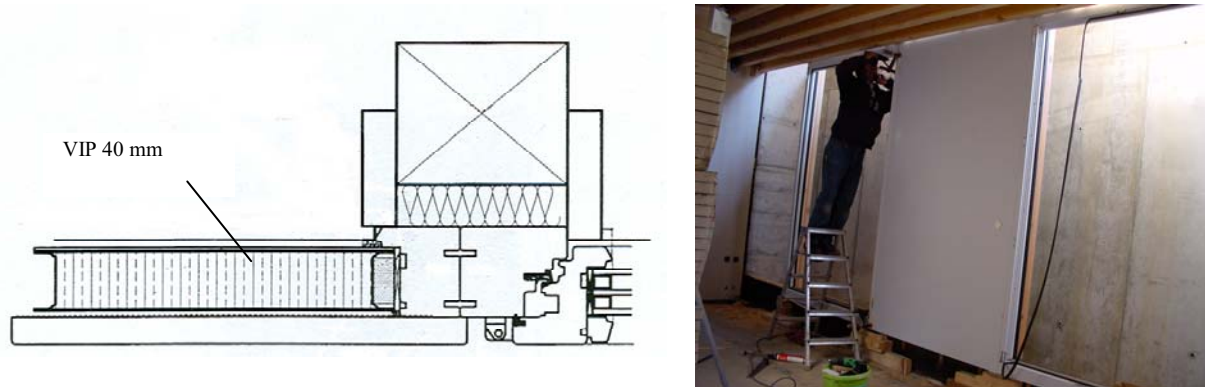

Figure 4: Vacuum insulation panels in the form of stainless steel cases used as outside wall elements on single-family terrace houses in Binningen / Switzerland

Left: Horizontal section through the construction

Right: Installation of the VIP

(Architect: Feiner Pestalozzi, Basel / Switzerland; Façade system: Häring AG, Switzerland)

1.3 Use of VIP – Recommendations

VIP is more than a new material – it must rather be regarded as a system, one of considerable complexity and sensitivity. It is therefore important that all concerned be informed, advised as early as possible and be supported by a specialist during the entire planning and installation process (preferably by the VIP supplier). In whatever way VIP are used in the construction branch, those responsible should make sure that during the planning and building process, no one handles VIP without having sufficient knowledge of its properties. Postal parcels with sensitive contents are marked with a 'Handle with care' label because they pass through many hands. VIP should, as a rule, fulfil their function in buildings over decades. Wherever they are not installed absolutely safe from damage, tenants, owners and renovation workers should also be warned with a label of the sensitive contents of building components. We thus recommend VIP manufacturers and suppliers to develop a warning label (Figure 5).

VIP must be handled with care and suitable protective measures and tools should be used (protective mats, felt shoes, etc.). The most important recommendations for handling VIP both in the factory on fabrication of components and systems, and also for direct installation on site are:

In order to minimize the edge effects of the VIP

- select panels that are as square and large as possible (min. 0.5 x 0.5 m²).
- If the envelope of the panel is made of aluminium foil – nowadays mostly multi-layer films are used – lay the panels in a double layer, overlapping by at least 5 cm (which, however, is expensive).



Figure 5: Draft sketch for an adhesive warning label to mark VIP panels and building components containing VIP

VIP must be well protected from mechanical damage. This applies equally to functional loading (e.g. from the floor), inadvertent loading (e.g. dilatation) and subsequent manipulations (e.g. nailing).

VIP are vapour-tight insulation systems, which has to be taken into account in planning the order and thickness of the layers. Furthermore, special attention must be given to the joints between the panels. The joints and edges are usually sealed with a special adhesive aluminium tape, which assures tightness but is relatively brittle.

The possibility of individual panels or entire areas failing should – at least to date – be included as a risk in the planning and execution. A strategy would be desirable that would aim at being able to replace the VIP in case of failure. This implies two things that in our experience to date are not usually paid attention to:

- Means should be sought in the design of the VIP system to facilitate replacement as much as practicable, if the particular application is expected to lead to a high failure rate.
- Installation of the VIP in such a way that inspection of their correct functioning can be made, particularly with infrared thermography. As a rule this is impossible if on both sides, either well conducting, massive covers (e.g. concrete) or back-ventilated constructions are employed (provided that the latter cannot be removed relatively simply for checking the VIP).

As a rule, one has limited oneself up to now to mitigating the effects of failure, so that a deterioration in the U-value can be accepted and it is assured that on loss of vacuum, there is no risk of loss of comfort or of condensation



2 Introduction to VIP for buildings

2.1 Development of insulation standards

Most insulation materials have been developed before 1950 but the extensive use of thermal insulation started only after the oil crisis in 1973. Since the oil crisis, the thermal insulation of buildings became the key element to prevent heat losses and to improve energy efficiency. For a long time, 10 cm of standard insulation such as Styrofoam, foamed PU, fibreglass, etc, were considered as good insulation. But energy specialists calculated that the economically optimised thickness should be 30-50 cm depending on climatic conditions. Today, many existing building regulations and standards demand U-values for roofs and walls of around $0.2 \text{ W}/(\text{m}^2 \cdot \text{K})$ which means insulation layers of about 20 cm. Many architects have a problem with such regulations. They want to create spaces, not insulated bunkers. The problem of thick insulations layers is especially critical in the case of renovated buildings where there are severe limitations on space and also many other technical constraints.

2.2 Energy in buildings

The effect on environment of a major adoption of the VIP (Vacuum Insulation Panel) technology by the construction industry is expected to be absolutely huge. Actually, the official numbers for the EU given below show that using VIP in buildings could account for most of the challenging target of 8% reduction in emission of greenhouse gases (Kyoto Protocol).

The total final energy consumption in the EU in 1997 was about 930 Mtoe (Million tons oil equivalent). A simplified breakdown of this demand shows the importance of buildings in this context: 40.7% of total energy demand is used in the residential and commercial sectors, most of it for building-related energy services (Table 1).

Table 1: Energy consumption of buildings in Europe. (Source: Directive of the European Parliament And The Council on the energy performance of buildings)

Residential Sector	[%]	Commercial	[%]
Space Heating	57	Space Heating	52
Water Heating	25	Water Heating	9
Electric Appliances	11	Lighting	14
Cooking	7	Office equipment	16
		Cooking	5
		Cooling	4

It should also be pointed out that approximately 10% of the consumed energy in buildings comes from renewable energy sources. Space heating is by far the largest energy end-use of households in EU Member States (57%), followed by water heating (25%).



Electrical appliances and lighting make up 11% of the sector's total energy consumption. For the commercial sector the importance of space heating is somewhat lower (52%), while energy consumption for lighting, office equipment and 'other' (water heating, cooking and cooling) are 14%, 16% and 18%, respectively.

From these numbers it can be derived that more than 25% of EU energy consumption and also CO₂ emissions are caused by heat transfer processes in buildings, which directly depend on insulation standards. It has to be kept in mind that these heat transfer processes do not only occur in the building envelope but also in boilers, refrigerators and freezers and cold storage rooms.

2.3 Potential impact of VIP for building insulation

In 1995, there were roughly 150 million dwellings in the EU-15, 32% of this stock was built prior to 1945, 40% between 1945 and 1975 and 28% between 1975 and 1995. The ratio housing starts vs. housing stocks varies between 1 to 2%. Therefore the reduction in CO₂ emissions by using VIP technology depends largely on how well the new technology is adopted in retrofitting the old building stock, which to a large extent (around 50%) is not insulated at all. This success depends not only on the technical solutions but also on regulations and energy prices. However, it can be assumed that the energy consumption of the dominating old buildings can be reduced by a factor of three. This means that the EU CO₂ emissions would be reduced by about 8%, which is the reduction the EU agreed on in the Kyoto Protocol. Since VIP-based systems are thinner and recycling economically attractive, the resource intensity will be lower than for conventional solutions. Additional important impacts are reduction in the bad environmental effects of transporting fuel (sea and land) to and inside Europe and also reduction in the rate we deplete the global energy reservoirs. Taking into account that use of the VIP technology will not be limited to Europe only, the numbers can be much more impressive.

2.4 Vacuum Insulation today

Vacuum Insulation Panels (VIP) have limited use mainly in top models home refrigerators/freezers and cold shipping boxes. Japan controls more of than 50% of the small global VIP market with several million panels per year. The VIP market in Japan is fast growing. The common core materials are fumed and precipitated silica, open cells PU and several types of fibreglass. Both metallized and aluminium-foil laminates are being used.

For buildings most of the VIP activity is still in the R&D phase with some demonstration projects. Germany and Switzerland are the only countries where a market in its early stage has been established. Almost exclusively fumed silica boards are being used. Fumed silica is the best core material due to the small size of the pores and the low heat conductivity of the powder. There are only three producer of fumed silica in the world, and two of them are large EU companies: Wacker (Germany), Cabot (USA) and Degussa (Germany).



3 VIP – A New Material for the Building Industry

3.1 Properties of VIP

The vacuum insulation panel (VIP) is a strongly non homogeneous insulation product due to the different thermal conductivities of its components (Figure 6). The contact between the solid particles of its vacuum packed-core material has been reduced to a minimum resulting in a conductivity of few milliwatt per meter and Kelvin in low pressure condition (up to 100 mbar). In contrast the pure aluminium layers in the barrier film wrapped around it to maintain this low pressure condition have a thermal conductivity of around 210 W/(m·K). The difference is 4 orders of magnitude. Additionally the joint between two adjacent VIP where seams meet each other and air layers are unavoidable, is a further inhomogeneity to be taken into account when calculating the overall heat loss through walls, façades and roofs containing VIP.

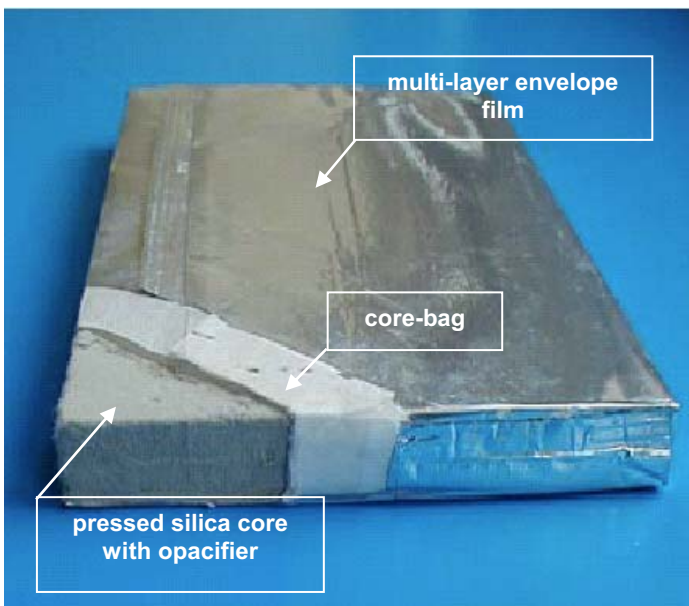

Figure 6: Components of a VIP. The core-bag provides mechanical stability for handling and protects the welding area from being polluted by core-powder.
(foto: va-Q-tec)

3.2 Aging, durability and risk factors

The centre-of-panel (cop) thermal conductivity λ_{cop} of a well evacuated dry VIP with a fumed silica core is typically about 0.004 W/(m·K) after production. As the low internal pressure is not in equilibrium with the environmental conditions, pressure gradients are present that act as driving forces for the intrusion of atmospheric gas. In this context one might distinguish



between aging and durability in the following sense: aging is a continuous process of performance degradation due to (normally) slow permeation of atmospheric gas molecules (essentially N_2 , O_2 and H_2O) through the non-perfect barrier, resulting in a non-reversible pressure increase and moisture accumulation in the hygroscopic VIP core. In contrast, durability is the ability of a VIP to withstand chemical or mechanical impacts that would cause failure of the barrier envelope, thus changing the internal low-pressure state within a short time by severe damage or rupture of the barrier.

Aging in terms of a continuous increase of the heat transfer both in the gaseous and in the moistened solid fraction of the core, was investigated in detail in IEA Annex 39 Subtask A for a wide range of environmental temperatures and vapour pressures (see Annex 39 Subtask A report [6]). It was found that the aging speed depends on a number of parameters such as barrier material, panel dimensions and temperature-humidity conditions in service. Focusing on state-of-the-art multiple metallized laminated polymer barriers and typical environmental conditions (23 to 25 °C and 50% RH), rough maximum values observed in the laboratory based aging experiments are given in Table 2. If a time span of 25 years is taken as a basis for the long-term performance (in analogy to European Standards on thermal insulation products [7]) it can be concluded that the pressure increase will be rather linear over the whole period, whereas the moisture content could approach the saturation range (about 0.04 kg/kg) within this time period. Using known relations for the pressure and moisture impact on the thermal conductivity (c.f. STA report), maximum values for the thermal conductivity after 25 years are given in Table 2 as well. These values represent maximum values of different products and are thought to be on the safe side in applications with VIP surface temperatures and vapour pressures in the range of ambient or indoor air.

Table 2: Aging of a VIP: pressure increase, moisture accumulation and thermal conductivity. Maximum values for VIP from different suppliers.

Thermal conductivity of a well evacuated dry VIP: $\lambda_{cop} = 0.004 \text{ W/(m}\cdot\text{K)}$

Quantity		50 x 50 x 2 cm ³	100 x 100 x 2 cm ³
Pressure increase	mbar/yr	2	1
Moisture accumulation	kg/(kg yr)	0.002	0.002
Thermal conductivity $\lambda_{cop}(25 \text{ yr})$	W/(m·K)	0.008	0.007

Regarding durability, the risks for VIP in suitable building applications occur mainly before or during installation. A certain failure rate is present at the production plant, caused by material imperfections or processing errors. This type of failure can be largely avoided by quality control as well as by storing the panels during a specified time under defined conditions and checking them before they are shipped. It can be stated that the rate of damaged or defective panels leaving the production plant was strongly reduced in the last few years. The figure is roughly assumed to be less than one percent. More frequent failures occur during transportation and handling of the panels until they are safely installed. Without protection the envelope is highly sensitive to mechanical impact, especially to point loads e.g. by sand grains, bricks or stone fragments, or other sharp objects including tools and corners of other panels. Once properly installed, failure risks are observed to be really low.



3.3 Thermal bridge effects

Thermal bridges are areas or spots in building constructions that have local high heat flows through this construction relative to the surrounding construction or have a local low inside surface temperature again relative to the surrounding construction. As a consequence, an increased heat loss through the building envelope or increased condensation risk at the inner surface of the building envelope occurs. For optimal application of vacuum insulation panels, it is therefore important to prevent cold bridges or to at least minimize their effect. Due to the structure of a VIP, however, thermal shunting cannot be excluded entirely.

Three different basic levels of thermal bridging for the application of VIP in building components can be identified:

1. thermal bridging due to the thin film high barrier enveloping the core material
2. thermal bridging due to building component edge spacers
3. thermal bridging due to the connection of the component to the load bearing structure by means of a window frame or post and mullion system

For in-situ applied vacuum insulation panels, also three different basic levels of thermal bridging can be distinguished:

1. thermal bridging due to the thin film high barrier enveloping the core material
2. thermal bridging due to the small air gap between two adjacent panels
3. thermal bridging due to constructional irregularities

3.3.1 Thermal bridging due to high barrier envelopes

Since vacuum insulation is a non-homogeneous material, the relatively highly conducting barrier envelope, which continues from the warm side to the cold side of the panel, forms a cold bridge at this panel edge (Figure 7).

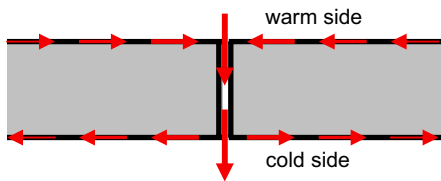

Figure 7: Schematic representation of a cold bridge between two VIP

Due to this cold bridge the effective or overall thermal conductivity, λ_{eff} , of the vacuum insulation panel is higher than the ideal centre-of-panel thermal conductivity. The amount of this cold bridge effect is also affected by the thermal properties material layers immediately surrounding the VIP. The effective thermal conductivity of a VIP takes all non-homogeneities, originating from the product itself as well as from the joint between adjacent VIP into account. In other words, the effective thermal conductivity of a VIP represents the conductivity of a homogeneous material with equivalent thermal behaviour. By means of measurements carried out in a guarded hot plate apparatus on VIP samples of three different thicknesses and two different sizes, the effective thermal conductivity, i.e. the linear thermal transmittance Ψ_{VIP} of the VIP themselves has been determined [1].



This effective thermal conductivity can be calculated as

$$\lambda_{eff} = \lambda_{cop} + \Psi_{VIP} \cdot d \cdot p / A \quad (1)$$

λ_{cop}	centre-of-panel thermal conductivity	[W/(m·K)]
d	thickness of the VIP (in the heat flux direction)	[m]
A	surface of the VIP (perpendicular to the heat flux direction)	[m ²]
p	perimeter of the surface A	[m]
Ψ_{VIP}	linear thermal transmittance	[W/(m·K)]

The linear thermal transmittance, Ψ_{VIP} , in equation (1) depends on panel thickness, d , centre-of-panel thermal conductivity, λ_{cop} , barrier film thickness, t_f , film thermal conductivity, λ_f , resulting in different values for the linear thermal transmittance for different laminates and the thermal properties material layers immediately surrounding the VIP (paragraph 3.3.5).

Figure 8 to Figure 10 show values for Ψ_{VIP} for different aluminium foils, stainless steel foils and one type of metallized film, consisting of three 12 μm metallized PET-layers and one approximately 60 μm thick HDPE sealant layer. As can be seen, the linear thermal transmittance for a typical 6 μm aluminium foil and for standard VIP thickness of 10 to 40 mm varies between 0.022 and 0.040 W/(m·K), while for a typical 50 μm stainless steel foil within the same thickness range, it varies from 0.015 to 0.038 W/(m·K) and for a three layer metallized laminate finally, it ranges from 0.008 to 0.010 W/(m·K).

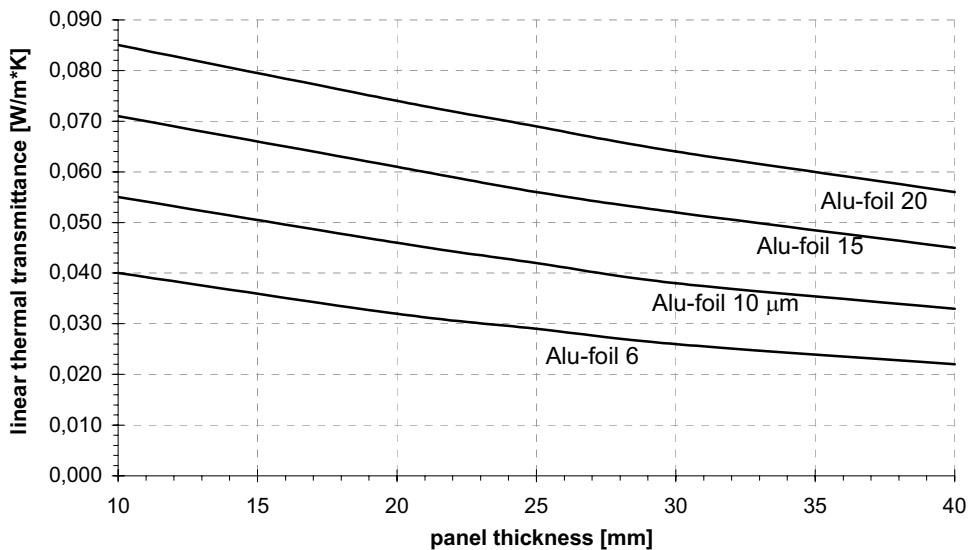

Figure 8: The effects of panel thickness and foil thickness on the linear thermal transmittance due to thermal bridging for an aluminium foil ($\lambda_{foil} = 200 \text{ W/(m·K)}$); $\lambda_{cop} = 4 \cdot 10^{-3} \text{ W/(m·K)}$, based on numerical calculation

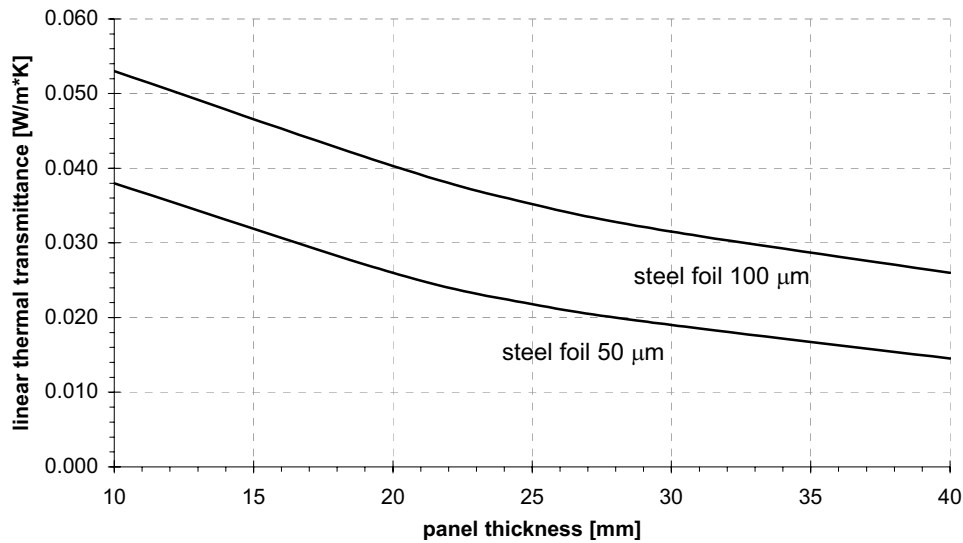

Figure 9: The effects of panel thickness and foil thickness on the linear thermal transmittance due to thermal bridging for a stainless steel foil ($\lambda_{foi} = 25 W/(m \cdot K)$; $\lambda_{cop} = 4 \cdot 10^{-3} W/(m \cdot K)$), based on numerical calculation

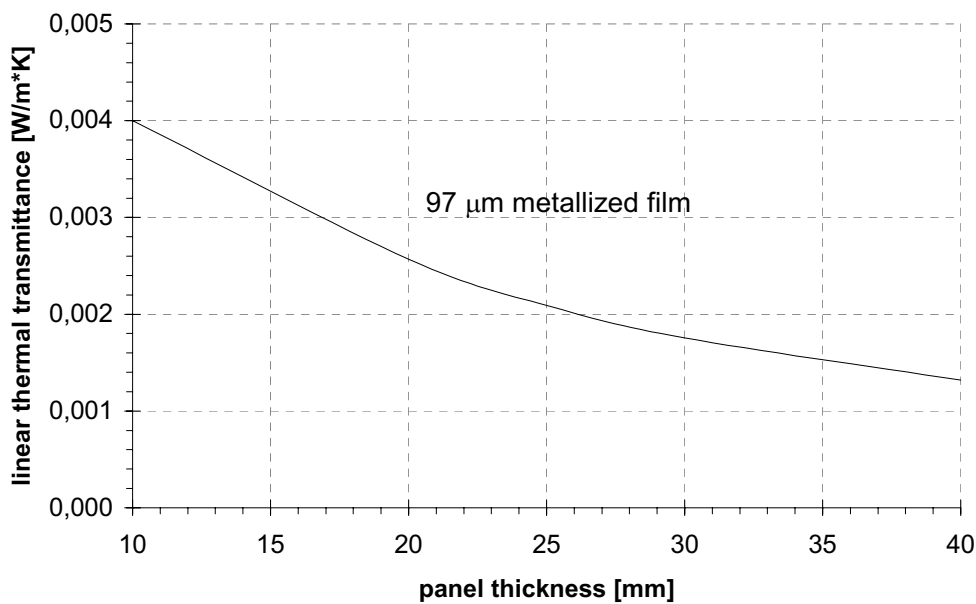

Figure 10: The effects of panel thickness on the linear thermal transmittance due to thermal bridging for a three layer metallized film; $\lambda_{cop} = 4 \cdot 10^{-3} W/(m \cdot K)$), based on numerical calculation

Based on these calculations and equation (1), effective thermal conductivities for different envelope materials can be calculated. Assuming a panel size of $1.00 \times 0.50 \times 0.02 m^3$ and a center-of-panel conductivity of $4 \cdot 10^{-3} W/(m \cdot K)$, it results:

- $8.6 \cdot 10^{-3} W/(m \cdot K)$ for an 8 μm aluminium foil (Psi: 0.038 $W/(m \cdot K)$),
- $7.1 \cdot 10^{-3} W/(m \cdot K)$ for a 50 μm stainless steel foil (Psi: 0.026 $W/(m \cdot K)$), and
- $5.1 \cdot 10^{-3} W/(m \cdot K)$ for a three layer metallized film (Psi: 0.009 $W/(m \cdot K)$).



Besides, experimental investigations on the thermal bridge effects of different high barrier films have been conducted at EMPA, from which the seam influence can be determined [1]. Table 3 shows some of the results of the experimental investigations with a guarded hot plate apparatus conducted at EMPA. As can be seen, the Ψ_{VIP} -value for specimen samples with seams are slightly higher than the values for specimens without seams, based on numerical simulation.

Table 3: Results of the experimental investigations of the thermal bridge effect of different high barrier envelopes conducted at EMPA. Summarized table taken from [1]

VIP	description	d [m]	λ_{cop} [W/(m·K)]	Ψ_{VIP} [W/(m·K)]
Type A	metallized barrier with 90 nm aluminium in total and large seam folded over the panel edge	0.020	$(4.14 \pm 0.08) \cdot 10^{-3}$	$(6.96 \pm 1.63) \cdot 10^{-3}$
Type B	metallized barrier with 300 nm aluminium in total and small seam folded at panel edge	0.020	$(3.91 \pm 0.08) \cdot 10^{-3}$	$(9.19 \pm 1.63) \cdot 10^{-3}$
Type C	laminated barrier with 8 μm aluminium layer and large seam folded over the panel edge	0.018	$(3.95 \pm 0.08) \cdot 10^{-3}$	$(52.44 \pm 3.34) \cdot 10^{-3}$

3.3.2 Modelling the VIP for numerical calculations

A complex model [5] taking into account every single layer in the barrier film (a total of 6) as well as the seam geometry and the air layers between two adjacent VIP did quite well in reproducing simple guarded hot plate measurements. Due to the multitude of very thin and highly conductive layers, this model was inapplicable for whole building details including surfaces paved with VIP.

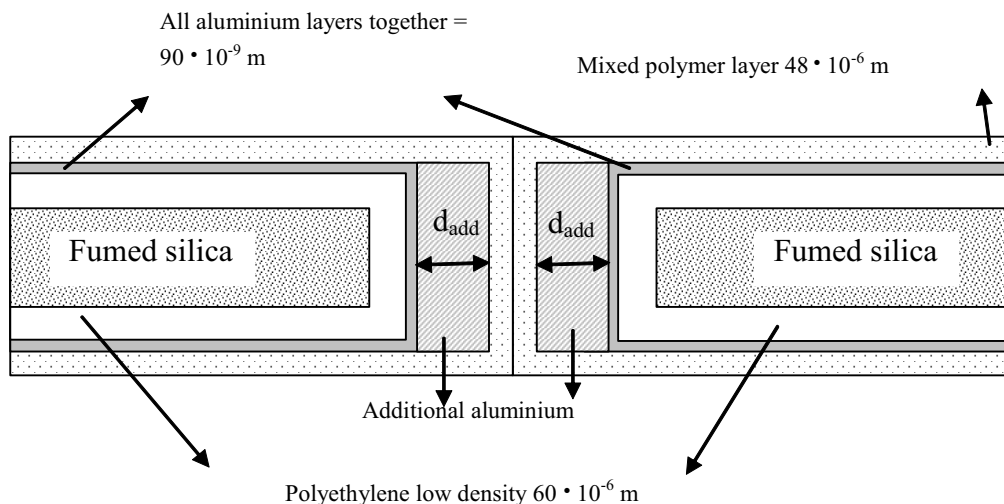

Figure 11: Section through a VIP. Simplified model of the VIP for numerical calculations

A simpler model (Figure 11) is presented here which is made of two essential parts, namely the core material and a simplified barrier film where the total aluminium layers are reduced to



one single layer. The joint between two VIP is represented simply by coarsening the aluminium thickness around the edge. In other words the whole geometrically and thermally complicated joint between two adjacent VIP is reduced to one single parameter. Assuming the thermal conductivity of coated aluminium as 230 W/(m·K) this additional thickness d_{add} was calculated by adjusting the numerical calculation to the experimental measurements.

3.3.3 An approximating model for calculating Ψ_{VIP} -values of aluminium foils

Since the thermal bridge effect of VIP barrier envelopes is especially important for aluminium foils, at Delft University of Technology an approximating model for calculating the Ψ_{VIP} -values of these foils was derived and validated by numerical calculations. For a detailed description of the assumptions, the derivation and validation it is referred to a document that can be obtained from the authors [2].

The linear thermal transmittance of aluminium high barrier foils enveloping an evacuated core can be estimated with

$$\Psi_{vip} \Big|_{\lambda_c=0} = \frac{1}{\frac{\varphi \cdot d_p}{t_f \cdot \lambda_f} + \frac{1}{\sqrt{\alpha_1 \cdot t_f \cdot \lambda_f}} + \frac{1}{\sqrt{\alpha_2 \cdot t_f \cdot \lambda_f}}} \quad (2) \text{ and}$$

$$\Psi_{vip} \Big|_{\lambda_c} = \Psi_{vip} \Big|_{\lambda_c=0} \cdot e^{-0,24 \cdot \frac{\lambda_c}{d_p}} \quad (3)$$

α_n	the heat transmission coefficient at boundary surface n	[m ² ·K/W]
d_p	the thickness of the vacuum insulation panel	[m]
t_f	the thickness of the foil	[m]
t'_f	the thickness of the foil near the seal	[m]
φ	the ratio t_f/t'_f	
λ_f	the thermal conductivity of the foil	[W/(m·K)]
λ_c	the thermal conductivity of the core	[W/(m·K)]

These equations (2) and (3) are valid only under the conditions of

- 1.) $\frac{\lambda_f}{\lambda_c} > 1.5 \cdot 10^4$ (4) and
- 2.) standard panel thickness of 10 to 30 mm with standard foil thickness.

Under these conditions the inaccuracy of the model is less than 3.0%.



Table 4: Comparison of the numerical data to equation (3) for different edge seam constructions. The calculation parameters are as follows: $d_p = 0.03$ m; $t_f = 7$ μ m; $\lambda_c = 4 \cdot 10^{-3}$ W/(m·K); $\alpha_i = 0.13$ m²·K/W; $\alpha_e = 0.04$ m²·K/W

seal type	Ψ_{VIP} [W/(m·K)]		φ [-] ¹
	numerical analysis		
	seal folded to inside surface	seal folded to outside surface	
no seal	0.029	0.029	1.00
a	0.048	0.048	0.33
b	0.036	0.036	0.67
c	0.041	0.039	0.67
d	0.032	0.031	1.00

3.3.4 A method to reduce the thermal bridge effect at the edge of VIP

Using metal foil, compared with metallized films, causes an increase of the thermal bridge effect at the edge of the VIP. The advantages of a metal foil are better gas and water vapour tightness and reduced sensitivity to mechanical damage. A possibility to reduce the thermal bridge effect using metal foil is actually lengthening the thermal bridge itself, to force the heat flow to wander along a longer path. This is achieved by folding the metal to a serpentine shape (Figure 14) [3].



Figure 14: Section through a VIP. Sketch of the serpentine construction

The metal chosen for this purpose is stainless steel. Firstly, it can survive aggressive environments with large humidity. Secondly, stainless steel has a considerably lower thermal conductivity in comparison to other metals. The gaps in the edges must be filled with a quite stiff insulating material. The choice is free on the outside, but on the inside it has to be an open porous material. The core materials used in today's VIP are often silica based powders. These powders present a super-insulating ability at relatively low vacuum levels. But if the vacuum is high enough, principally all open porous insulating materials can be used. In the range 0.1-0.5 mbar the lambda value for ordinary glass wool has decreased from

¹ Seal construction a can easily be calculated by using the value 0.33 ($= \frac{\lambda_c}{t_f} / \lambda_c = 1/3$) for φ . Seal construction b and c can be estimated by averaging the no seal construction and seal construction a.



0.036 W/(m²·K) to below 0.005 W/(m²·K). The disadvantage in using these materials is that pressure built up over time is much more devastating and the thermal resistance drops significantly faster with increased pressure. This will reduce the lifetime of the panel, which is the reason why more advanced and micro-porous materials are used. Another factor controlling the pressure build-up is gas emission from the core material itself. With proper pre-treatment, like drying in high temperatures and using moisture and gas absorbing substances, this effect can be minimized. If a practically impermeable barrier layer can be used, the risk of pressure build up over time is lowered. This opens up the opportunity to use for example mineral wool or open cell polystyrene. Of course micro porous materials can still be used. The choice of core material is open.

This work presents computer modeling performed on the edge solution. The modeling has been made in two programs, GF2DIM and Femlab. GF2DIM is quite an old two-dimensional program made for calculating thermal bridges. Femlab is modern software that uses partial differential equations to solve various multi-physics problems. The results from these calculations show that the edge effect compared to simple folding at the edge can be reduced by 60% using the serpentine construction. For a 22 mm thick panel a theoretically calculated edge with 7 turns gives a Ψ -value of ca 0.03 W/(m·K).

One goal in this project was to make prototypes of both the serpentine edge and a VIP using this edge. The goals were partially achieved. A model of the edge was made in the first place: it was constructed of thin stainless steel folded to the desired shape. The gaps were filled with polyurethane foam.

A complete panel was also made, but large practical problems with the corners prevented the panel from being made airtight, at least not in the timeframe of this thesis. Another problem is that it is hard to weld stainless steel this thin, but with the proper equipment it is clearly possible. The thickness of the steel used in the edges was 0.15 mm. The joining of the parts was solved by using industrial epoxy glue. This works fine, but testing has to be made to see how the joints stand the large thermal movements that can arise when the panels are used in environments with large temperature changes. Another difficulty with using epoxy glue is that it requires a long time to harden.

The corner problem is the absolutely largest obstacle having to be overcome. The solution in this case was to file the ends of the edges to 45 degrees and then join them together with epoxy glue and a thin layer of metal in between. The big disadvantage of doing this is that when the panel is evacuated it will compress, but the corners are stiff and will not follow the movement. It is also very difficult to get the corners airtight and leak spots are almost impossible to locate. The conclusion is that in future, manufacture of the edges and the corners has to be carried out in one piece. This is probably not possible to do by hand, so cooperation has to be made with expertise in thin steel work. On the bright side, the folding process to obtain the serpentine shape is quite easy and can be done by hand using the proper tools. Vacuum panels made this way will probably never compete with standard VIP in price, unless a very effective manufacturing process is developed.



3.3.5 Influence of adjacent materials on thermal bridging

As well as the properties of the core material and the envelope, the Ψ_{VIP} value is influenced by the material layers immediately surrounding the VIP. At the EMPA the influence of various surrounding materials has been investigated. The calculations were performed for a VIP (20 mm) with metallized enveloping laminate for the adjacent materials metal, glass, wood and insulation, in each case without an air gap between the VIP and with a 5 mm air gap between the VIP. The calculations were performed with the program TRISCO. Table 5 shows a summary of the installation situations investigated, the Ψ_{VIP} values and λ_{eff} values for VIP of the sizes 50 x 50 cm², 50 x 100 cm² and 100 x 100 cm² with a λ_{cop} of $8 \cdot 10^{-3}$ W/(m·K).

Material layers adjacent to VIP with a high thermal conductivity lead to a deterioration of the λ_{VIP} values. As far as possible, therefore, insulating materials, wood or other substances should be used having a low thermal conductivity. More detailed investigations have been summarized in the form of a collection of building components in [4].

Table 5: Ψ_{VIP} values as a function of different adjacent materials and the resulting λ_{eff} values for different panel sizes

Material	Ψ_{VIP} [W/(m·K)]	λ_{eff} 100x100 [W/(m·K)]	λ_{eff} 50x100 [W/(m·K)]	λ_{eff} 50x50 [W/(m·K)]
2 mm Steel 20 mm VIP / no air gap 2 mm Steel	0.011	0.0089	0.0093	0.0098
5 mm Glass 20mm VIP / no air gap 5 mm Glass	0.009	0.0087	0.0091	0.0094
20 mm Wood 20 mm VIP / no air gap 20 mm Wood	0.006	0.0085	0.0087	0.0090
5 mm Insulation 20 mm VIP / no air gap 5 mm Insulation	0.005	0.0084	0.0086	0.0088
2 mm Steel 20 mm VIP / 5 mm air gap 2 mm Steel	0.019	0.0095	0.0103	0.0110
5 mm Glass 20mm VIP / 5 mm air gap 5 mm Glass	0.016	0.0093	0.0099	0.0106
20 mm Wood 20 mm VIP / 5 mm air gap 20 mm Wood	0.010	0.0088	0.0092	0.0096
5 mm Insulation 20 mm VIP / 5 mm air gap 5 mm Insulation	0.007	0.0086	0.0088	0.0091



Material	Ψ_{VIP} [W/(m·K)]	$\lambda_{eff\ 100 \times 100}$ [W/(m·K)]	$\lambda_{eff\ 50 \times 100}$ [W/(m·K)]	$\lambda_{eff\ 50 \times 50}$ [W/(m·K)]
5 mm Insulation	0.0016	0.0081	0.0082	0.0083
10 mm VIP / no air gap				
10 mm VIP / no air gap				
5 mm Insulation	0.0012	0.0082	0.0083	0.0084
5 mm Insulation				
20 mm VIP / no air gap				
20 mm VIP / no air gap				
5 mm Insulation				

3.3.6 Thermal bridging due to façade panel edge constructions

Within the design process of façade panels, the influence of the edge spacer construction on the thermal property of the façade panel should be attended. Two façade panel constructions have potential for VIP integrated façade components: the sandwich construction and the edge spacer construction (Figure 15).

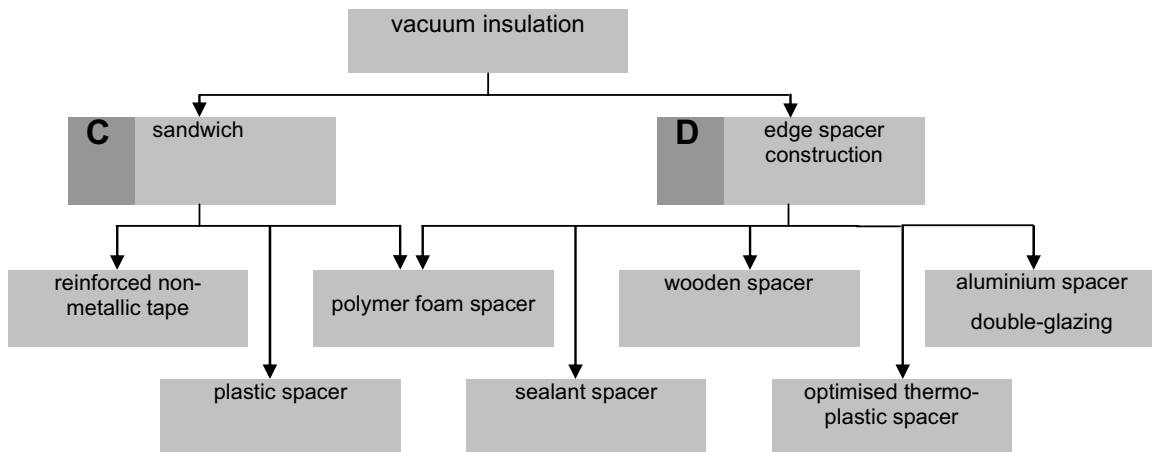

Figure 15: Overview of different edge spacers

The difference between the two types of construction lies in the load transmitting system of the components. With edge spacer constructions both component facings are mechanically jointed by means of a load transmitting edge spacer, while with the sandwich construction the component facings are adhered to a core material to form a structurally active sandwich. This sandwich construction, contrary to the edge spacer construction, does not require a section at the panel sides, though it might be wise for protection of the VIP against damage. As a consequence, thermal bridge effects due to the spacer are significant especially for edge spacer constructions. Thermal calculations with the 3D steady-state simulation software TRISCO have therefore been conducted at TUDelft to estimate Ψ_{VIP} –values for different edge spacers, which are shown in Figure 16.

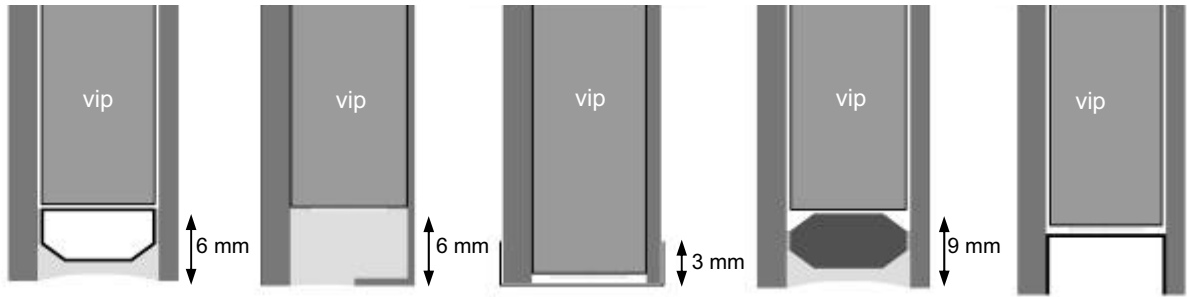

Figure 16: Different edge spacers. a.) aluminium spacer double-glazing; b.) sealant spacer; c.) reinforced non-metallic tape (0.15 mm); d.) optimised thermoplastic spacer (Henkel Tereson Thermoplastic Spacer); e.) polymer U-section

For the calculations the following edge spacer materials were used:

Edge spacer a: standard double-glazing aluminium edge spacer ($\lambda = 225 \text{ W/(m}\cdot\text{K)}$)
polysulfide sealant ($\lambda = 0.40 \text{ W/(m}\cdot\text{K)}$) and silicon sealant
($\lambda = 0.35 \text{ W/(m}\cdot\text{K)}$)

Edge spacer b: butyl sealant ($\lambda = 0.24 \text{ W/(m}\cdot\text{K)}$)

Edge spacer c: non-metallic tape ($\lambda \approx 0.33 \text{ W/(m}\cdot\text{K)}$); thickness $\approx 0.15 \text{ mm}$

Edge spacer d: thermoplastic spacer ($\lambda = 0.25 \text{ W/(m}\cdot\text{K)}$)
polysulfide ($\lambda = 0.40 \text{ W/(m}\cdot\text{K)}$)

Edge spacer e: polymer U-section ($\lambda = 0.40 \text{ W/(m}\cdot\text{K)}$); thickness = 0.5 or 1.0 mm
adhesive ($\lambda = 1.0 \text{ W/(m}\cdot\text{K)}$)

Fumed silica based VIP

(Table 6 and Table 7: $\lambda_{\text{cop}} = 0.004 \text{ W/(m}\cdot\text{K)}$; Table 8 and Table 9: $\lambda_{\text{cop}} = 0.008 \text{ W/(m}\cdot\text{K)}$)

Table 6: Calculation results for the linear thermal transmittance (ψ [$\text{W/(m}\cdot\text{K)}$]) for different edge spacers constructions. VIP: $\lambda_{\text{cop}} = 0.004 \text{ W/(m}\cdot\text{K)}$

	outside facing:	glass 6 mm		
	insulation:	vacuum insulation panel 20 mm		
	inside facing:	trespa 3 mm	aluminium 1.5 mm	steel 0.75 mm
spacer a	6 μm aluminium foil	0.129	0.355	0.258
	Mylar film	0.103	0.310	0.230
spacer b	6 μm aluminium foil	0.055	0.141	0.120
	Mylar film	0.016	0.095	0.084
spacer c	6 μm aluminium foil	0.054	0.066	0.064
	Mylar film	0.011	0.011	0.011
spacer d	6 μm aluminium foil	0.089	0.108	0.103
	Mylar film	0.059	0.070	0.068



Table 7: Calculation results for the linear thermal transmittance (Ψ [W/(m·K)]) for the edge spacer e constructions with different facings and spacer thickness. VIP: $\lambda_{cop} = 0.004$ W/(m·K)

		outside facing:	mdf* 4 mm	Glass 4 mm	aluminium 2 mm
		Insulation:	vacuum insulation panel 20 mm		
		inside facing:	mdf 4 mm	Glass 4 mm	aluminium 2 mm
spacer e	1.0 mm	6 μ m aluminium foil	0.074	0.080	0.130
		3-layer metallized film	0.053	0.060	0.085
spacer e	0.5 mm	6 μ m aluminium foil	0.073	0.078	0.122
		3-layer metallized film	0.051	0.058	0.079
spacer e	insulated air gap	6 μ m aluminium foil	0.052	0.055	0.074
		3-layer metallized film	0.024	0.025	0.030

*mdf: medium density fibreboard

Table 8: Calculation results for the linear thermal transmittance (ψ [W/(m·K)]) for different edge spacers constructions. VIP: $\lambda_{cop} = 0.008$ W/(m·K)

		outside facing:	glass 6 mm		
		insulation:	vacuum insulation panel 20 mm		
		inside facing:	trespa 3 mm	aluminium 1.5 mm	steel 0.75 mm
spacer a		6 μ m aluminium foil	0.125	0.338	0.248
		Mylar film	0.101	0.297	0.223
spacer b		6 μ m aluminium foil	0.066	0.134	0.113
		Mylar film	0.044	0.101	0.088
spacer c		6 μ m aluminium foil	0.052	0.063	0.060
		Mylar film	0.010	0.011	0.011
spacer d		6 μ m aluminium foil	0.084	0.104	0.097
		Mylar film	0.056	0.069	0.066

Table 9: Calculation results for the linear thermal transmittance (Ψ [W/(m·K)]) for the edge spacer e constructions with different facings and spacer thickness. VIP: $\lambda_{cop} = 0.008$ W/(m·K)

		outside facing:	mdf* 4 mm	Glass 4 mm	aluminium 2 mm
		Insulation:	vacuum insulation panel 20 mm		
		inside facing:	mdf 4 mm	Glass 4 mm	aluminium 2 mm
spacer e	1.0 mm	6 μ m aluminium foil	0.070	0.075	0.122
		3-layer metallized film	0.050	0.056	0.079
spacer e	0.5 mm	6 μ m aluminium foil	0.069	0.074	0.117
		3-layer metallized film	0.048	0.054	0.081
spacer e	insulated air gap	6 μ m aluminium foil	0.049	0.051	0.068
		3-layer metallized film	0.022	0.023	0.026

*mdf: medium density fibreboard



For the VIP envelope, three different laminates have been used for the calculations: a 6 μm aluminium foil, a three-layer metallized film of total 97 μm thickness and a Mylar film. The calculated Ψ_{VIP} -values are values for one side of the panel, which means that the Ψ_{VIP} -value for the connection between two adjacent panels is twice this calculated value.

Table 6 to Table 9 show the results of the numerical calculations. As can be seen, for polymer and metallized films the thermal bridge effect is smaller than for metal foils. It is therefore best to use metallized films for vacuum insulation panels, despite the fact that aluminium foils have better barrier properties against gas and water vapour permeation, resulting in a longer service life.

As can be seen as well, aluminium spacers (spacer a) are not suitable for façade panels with incorporated vacuum insulated panels, because a linear thermal transmittance, Ψ , of approximately 0.25 to 0.35 (Table 6 for $\lambda_{cop} = 0.004 \text{ W}/(\text{m}\cdot\text{K})$) leads to an increase in effective U-value for a panel of $1 \times 1 \text{ m}^2$ with 20 mm vacuum insulation panel from approximately 0.2 to $1.2 \text{ W}/(\text{m}^2\cdot\text{K})$ or $1.6 \text{ W}/(\text{m}^2\cdot\text{K})$, for $\lambda_{cop} = 0.008 \text{ W}/(\text{m}\cdot\text{K})$ from 0.4 to $1.39 \text{ W}/(\text{m}^2\cdot\text{K})$ or $1.75 \text{ W}/(\text{m}^2\cdot\text{K})$, i.e. an increase of 300% or more. Better performances can be expected from the spacers b and d, while the best performance is calculated for the reinforced non-metallic tape (for $\lambda_{cop} = 0.004 \text{ W}/(\text{m}\cdot\text{K})$ the U-value $U_{eff} = 0.46 \text{ W}/(\text{m}^2\cdot\text{K})$ for a 20 mm vacuum insulation panel construction with an aluminium foil and $U_{eff} = 0.24 \text{ W}/(\text{m}^2\cdot\text{K})$ for a 20 mm vacuum insulation panel construction with a metallized polymer film; for $\lambda_{cop} = 0.008 \text{ W}/(\text{m}\cdot\text{K})$ the U-values are $0.65 \text{ W}/(\text{m}^2\cdot\text{K})$ and $0.44 \text{ W}/(\text{m}^2\cdot\text{K})$). This reinforced tape, however, might not adequately transmit forces, especially if wind suction is the main load to be transmitted. For sandwich panels, however, this edge spacer does not have to transmit loads and can thus be used for safety and protection against damage.

3.4 Mechanical properties

At Delft University of Technology three-point and four-point bending tests have been conducted on 20 mm thick fumed silica core based vacuum insulation panels and on sandwich panels made of a the same 20 mm thick vacuum insulation core panels and 4 mm thick mdf (Medium Density Fibreboard) or glass facings² (Figure 17) . The tests were conducted according to ASTM C 393: *Standard Test Method for Flexural Properties of Flat Sandwich Construction*.



Figure 17: The layout of sandwich panels

² The adhesive used to fix the facings on the vacuum insulation is a Polyurethane based glue. All panels have an overhang at both ends of 25 mm and the distance between the load points of the four-point bending apparatus are 150 mm for the $150 \times 350 \text{ mm}^2$ and 300 mm for the $150 \times 550 \text{ mm}^2$ and $150 \times 750 \text{ mm}^2$ panels. The radius of the load points was 10 mm. The vacuum insulation panels consist of a fumed silica core with a laminated metallized polymer high barrier film.



Table 10 summarizes the measured flexural mechanical properties for single vacuum insulation panels (vacuum insulation panel intact and vacuum insulation panel damaged). As can be seen by comparing the results with the data on fumed silica panels themselves (Chapter 2 in Report of Subtask A), vacuum insulation panels have a Young's modulus higher than the single fumed silica core material itself. This, however, is not so astonishing, because the core is restricted in its movement by a low gas pressure, i.e. vacuum, and a high barrier envelope. The value for the Young's modulus, however, is rather low compared to for example steel, aluminium, glass or the high barrier envelope, which have moduli of 210000, 70000, 70000 and approximately 2000 MPa respectively. Vacuum insulation panels are therefore preferably applied in situations in which no big flexural loads act upon the panels.

Table 10: Flexural properties of vacuum insulation panels

	Flexion Modulus VIP MPa	Ultimate Flexural Strength VIP kPa	Deformation at Yielding VIP %	Deformation at Fracture VIP %
VIP, intact	63.8 ± 8.6*	639.8 ± 109.9*	1.34 ± 0.38*	-
VIP, no vacuum	38.6 ± 10.7*	611.6 ± 45.3*	0.80 ± 0.16*	-

* uncertainty for a 95% confidence interval

Table 10 also shows that damaged vacuum insulation panels are less stiff than undamaged panels, whereas the ultimate flexural strength of both panels is more-or-less equal. This indicates that the pressure difference caused by the vacuum on one side has a significant influence on the Young's modulus but not on the strength of the panel. For practical purposes in the case of a perpendicular to surface loaded panel, thus, a loss of vacuum will increase the deflection of the panel with a factor 2, but will not cause the panel to fail directly. So, additional safety precautions are not required, unless indirect failure due to slipping out of its grooves is imminent. This, however, could actually only be the case if vacuum insulation panels are applied without a protecting and load bearing facing on both sides, which is only a theoretical situation.

For application of vacuum insulation panels as part of constructional (façade) elements, it is important to know the mechanical flexural behaviour of such sandwich panels. Flexion tests on sandwich panels have therefore been conducted at Delft University of Technology as well. The results of these tests for sandwich panels with a vacuum insulation panel core for different facings are presented in Table 11. As can be seen from comparing the data in Table 10 and Table 11, the values for the Young's modulus of the vacuum insulation panel obtained from in-panel measurements are more-or-less equal to the values obtained from single panel measurements, although the modulus of elasticity for undamaged panels obtained from in-panel measurements (Table 11) are slightly higher. This effect, if significant, might be a result of better load diffusion due to the panel facings. Although the vacuum insulation panels themselves seem to be rather flexible, the entire flexural stiffness of a sandwich panel is dominated by the Young's modulus and the area moment of inertia of the facings. A sandwich panel is therefore stiffer than a single vacuum insulation panel. This effect is responsible for the differences in deformation at fracture between sandwich panels with mdf and glass facings. So, despite their low value for the modulus of elasticity, vacuum insulation panels can be applied in sandwich panels, as long as the distance between both facings is



enough to have sufficient flexural stiffness.

Table 11: Flexural properties of sandwich panels with vacuum insulation panels as core material and different facings. The ultimate fracture strength is the normal stress at which the facing fails.

	Flexion Modulus VIP MPa	Shear Modulus MPa	Ultimate Flexural Strength Panel MPa	Deformation at Fracture Panel %
Mdf facing VIP, intact	83.1	27.3	4.3 ± 0.6*	12.2 ± 4.5*
Mdf facing VIP, no vacuum	34.0	12.9	3.9 ± 0.5*	12.3 ± 0.6*
Glass facing VIP, intact	86.2	62.9	4.1 ± 1.6*	1.2 ± 0.3*
Glass facing VIP, no vacuum	36.9	31.3	4.1 ± 0.5*	1.5 ± 0.3*

* uncertainty for a 95% confidence interval

The measured data are representative for panel dimensions of 350x150 mm². At this time it is uncertain whether the data can be used for structural calculations on panels of different dimensions or not, because the influence of the high barrier envelope and the vacuum on the mechanical behaviour on a microscopic level has not yet been fully investigated.

3.5 Life Cycle Analysis

Vacuum insulation panels (VIP) are increasingly becoming an alternative to conventional insulating materials. Their lower thickness for the same heat resistance proves to be an enormous advantage in a large number of building structures, an advantage for which one is ready to pay more. In Switzerland and Germany, VIP are already being used to a considerable extent. However, the question repeatedly arises as to whether the use of VIP is problematic from an energetic and ecological standpoint: whether in the final analysis, more energy is absorbed in the manufacture of VIP than is actually saved, and whether more ecological damage is caused during production than benefits accrue at the end.

The Institute of Energy at the University of Applied Sciences Basel has investigated the questions concerning the environmental effects of VIP using the life cycle analysis (LCA) methodology [15]. Using the three methods of environmental impact assessment (Eco-indicator 99 [8], the Method of Ecological Scarcity UBP97 [9] and the Cumulated Energy Consumption CEC [10]) VIP is compared with two well-known insulating materials (glass wool, polystyrene EPS). In the inventory of extractions and emissions, the energy and material flows in the process required for the production of the VIP are calculated. For background processes (provision of energy, transport services, disposal services, etc.), use is made of already available inventory data from the reference book 'Oekoinventare von Energiesystemen' [11] and the internal company data bank of ESU-services [12].



For a comparative life cycle analysis study of thermal insulation materials, a number of assumptions must be made, boundary conditions specified and use made of today's sometimes very short-lived facts, some of which have a considerable effect on the result. Some of the major assumptions in the present study are:

- The insulation material comparison refers to one square metre of wall construction with an U-value of $0.15 \text{ W}/(\text{m}^2 \cdot \text{K})$ or rather the quantity of insulation material or VIP required.
- A VIP is assumed with a core of fumed silica, encapsulated in gastight foils. The importance of various foils is investigated, but not that of alternative cores.
- Fumed silica is a by-product of high-purity silicon production for electronic chips. The common precursor silicon tetrachloride, for example, is highly energy intensive in its manufacture. The allocation of environmental pollution from this precursor process to the individual products is done in proportion to their market prices. The production of silicon tetrachloride dominates the results of the ecobalance to over 60%.
- Evaluation was carried out by all three life cycle assessment methods currently used in Switzerland, Eco-Indicator 99, Environmental Pollution Points UBP97 and the Method of Cumulated Energy Consumption CEC (embodied energy). The data for polystyrene and glass wool are taken from Weibel/Stritz 1995 [13] and Richter et al. 1995 [14], respectively.

The effectiveness of conventional insulating materials is based on enclosing as much air in as little material as possible in cells that are as small as possible. Insulating materials are thus light materials, i.e. they contain little material compared e.g. with brick, concrete, glass or even wood. The LCAs of insulating materials hence show in general that upon use in building skins, the benefits by far outweigh the ecological disadvantages, even with very good insulation. Thermal insulation plays a minor role in the assessment of environment effects for an entire building. The main result, in summary, of the present LCA study is that this essentially also applies for vacuum insulation. Whether VIP performs better or worse than glass wool or polystyrene, depending on the method of evaluation, does not change this basic fact. Moreover, the VIP upon which this study is based is a kind of pre-commercial product, not yet optimized in respect of environmental effects, but which has a great potential for improvement. For instance, because it is a by-product, one works with high purity silicon tetrachloride, although this is completely unnecessary for the VIP. If VIP were to be produced on a large scale, the manufacturing process ought to be less energy intensive and polluting. All known and presently used alternatives to fumed silica for the core material also feature less production energy consumption (but do not exhibit the same favourable properties for VIP).

The LCA of VIP is primarily dominated by the high consumption of production energy. The material flow aspects thus become secondary. For instance, the aluminium coated foil or the type of foil selected play a completely subordinate role. In this sense it is unimportant from the standpoint of an LCA of the material whether VIP is installed in one or two layers (in order to reduce thermal bridges at the edges by overlapping the panels).

Considering the fact that the results of the LCA are basically favourable for all the insulating materials studied, incl. VIP, it is not surprising that the use of different evaluation methods can lead to changes in the ranking order. The smaller the differences, the more likely are such changes. Evaluation with the Method of Ecological Scarcity (UBP97) rates VIP slightly poorer, but on the whole in the same order of magnitude as glass wool and polystyrene



(Figure 18 right). The dominant factor here is primarily the high energy consumption (especially electricity) used in the production of VIP. From the standpoint of Eco-indicator 99, however, mainly through the evaluation of the resources for EPS, vacuum insulation is moved to the middle field of the evaluation (Figure 18 left).

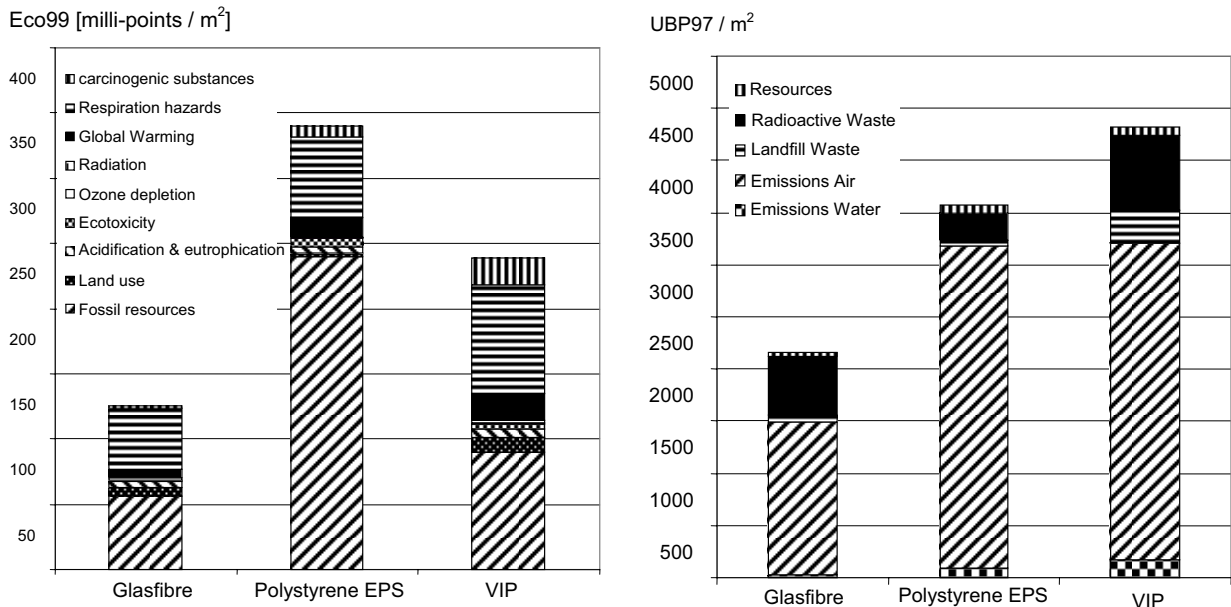

Figure 18: Left: Comparison of the categories of effects for the insulating materials glass wool, polystyrene EPS and VIP according to the method Eco-indicator 99
 Right: Comparison of the insulating materials glass wool, polystyrene EPS and VIP according to the Method of Ecological Scarcity with environmental pollution points UPB 97

In the dominance analysis according to Eco-indicator 99 Hierarchist default, above all, the fact dominates that most of the VIP components are produced in a highly energy-consuming manner (primarily with electricity). 90% of the overall evaluation of VIP comes from this area (silicon processing industry).

With the sensitivity assessment, possibilities of process optimization are indicated, by which the evaluation of VIP is moved into the area occupied by glass wool. The latter showed up best in the present comparison. Through substitution of an energy-critical component (silicon carbide, SiC) by a suitable replacement and optimization of procurement of the precursor of a further component (silicon tetrachloride), the inventory of effects for all the methods could be improved by around 45%. One can certainly expect process optimization of this kind when VIP is manufactured on a large scale. The environmental friendliness will hence be further improved with increasing market penetration.



4 Practice-Report

The U-values reported in this chapter are based upon data for lambda values from the VIP manufacturers. Aging and edge effects (see Chapter 3) were not able to be considered uniformly for this reason. Use of the details described would require prior clarification of the building physics and calculations in each individual case.

4.1 Floor and ceiling insulation

Attachment to a single-family house in Zug/Switzerland

Location:

Höhenweg 5
CH-6300 Zug

Architect and owners:

R. Zai, Zai & Partner
Zugerstr. 53
CH-6340 Baar

VIP: Vacucomp 20 mm in floor and ceiling construction, ZZWancor



Figure 19: Single-storey studio construction in the embankment above open garage and below walk-on terrace

Attachment of a single-storey studio with a garage as the basement. The construction was executed in a topographically complicated situation inside a steep embankment. Above all, the height is extremely limited and a realization would be practically impossible with conventional insulation, even if it were restricted to the minimum legal requirement. The interior of the studio is systematically insulated on the inside. The walls, mostly against the earth, are



insulated on the room side with 18 cm of foam glass. 2 cm of VIP is laid on the concrete floor (with the garage below). Above the ceiling lies the planted terrace of the house. 2 cm of VIP are also installed on the inside of the ceiling.

Comment:

In the present case the architect is both owner and user of the studio construction. In this situation he knowingly took risks in order to try out this new material in practice and investigates its behaviour and how it proves itself as an interior insulation with a very low U value. The architect considers this type of application of VIP to be insufficiently tested for use in clients' projects at present.

4.1.1 Material and construction

At the ceiling, the VIP were fitted between wooden laths.

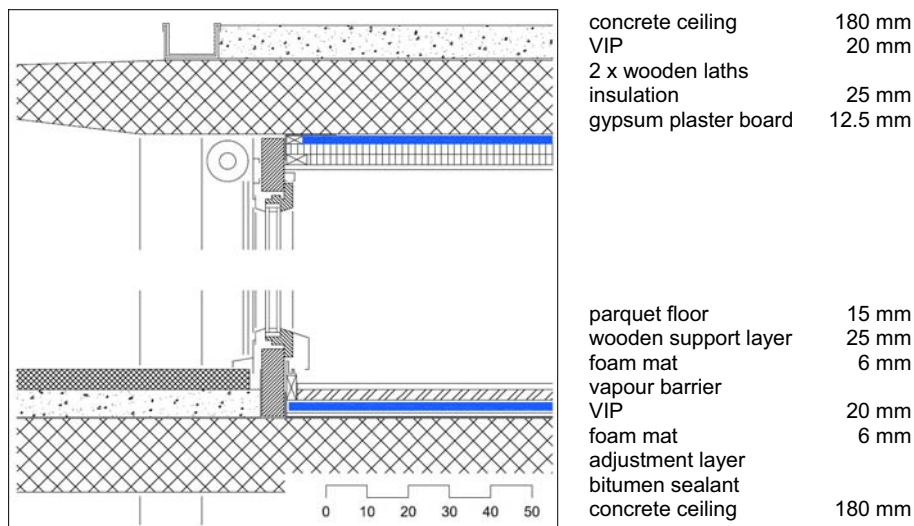

Figure 20: Vertical section, joint between the VIP construction and the window front

4.1.2 Building physics and engineering

Thermal bridges

The studio construction is systematically insulated on the inside. Since we are dealing here essentially with a single large room (with only light, mobile separations), it is possible to avoid fixed penetrations of the insulation layer to a large extent. Three reinforced concrete supports are the exception: these form major thermal bridges both in the ceiling and in the floor. These supports have (for the moment, at least) been left uncovered and will have very low surface temperatures during cold weather. However, since we are dealing here not with living space but a kind of office and the owner-architect is familiar with the issue, the room humidity can be kept lower during critical periods and one will be able to see whether surface condensation occurs.

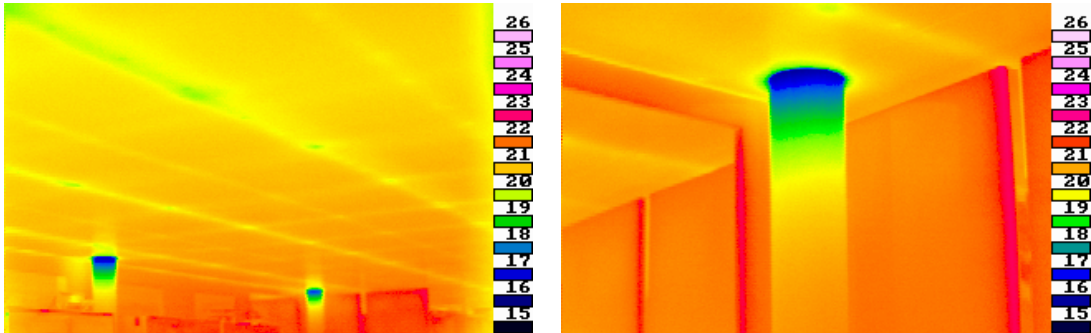

Figure 21: Concrete pillars passing from the roomside through the VIP-layer to the outside concrete roof slab. Pictures with the IR-Camera

Water vapour diffusion and material dampness

The VIP were adhered to both the floor and the ceiling with adhesive aluminium tape and joined to the edges. The VIP form an absolute vapour barrier. The sealing membrane on the outside of the flat roof also forms a vapour barrier, so that one must take great care that no humidity (from construction or rain) is sealed between these two vapour barriers. In the present case, a similar situation also exists at the floor, where a bituminous water barrier is laid below the poured cement floor. It was hence particularly important to dry out this flooring before laying the VIP.

Behaviour on vacuum failure

In the case of partial or large-area failure of the vacuum seal, the U value of the floor construction would drastically deteriorate from 0.3 to 0.6 W/(m²·K). In spite of this, the insulation would not drop below the minimum insulation from the aspect of building physics (risk of condensation). In the case of the ceiling construction, the situation is anyway non-critical because of the additional 5 cm of glass fibre insulation (deterioration from 0.24 to 0.38 W/(m²·K)). On the other hand, one must taken into consideration with the ceiling insulation that the (absolutely) vapour-tight VIP surface is covered by 5 cm of fibre insulation. At -10 °C outside temperature, the inner surface temperature of the VIP is 9 °C, 4 °C with vacuum failure. In the region of the wood laths between the VIP, the temperature is significantly lower! Hence not only in the case of failure must one provide a vapour barrier on the warm side of the fibre insulation panels to prevent condensation on the VIP or the wood laths.

4.1.3 Planning and execution procedure

The VIP supplier prepared exact laying plans based upon the building plans and drew up parts lists there from. The standard panel size was 100 x 60 cm². 255 of these panels covered over 90% of the area; for the remaining area, over 30 customized panels were supplied in quantities of between 1 and 13.

The VIP were delivered in large cardboard boxes, which were quite cumbersome and weighed over one hundred kilograms. The boxes had to be carried by hand up to the first floor. It was essential to store them before laying according to a logistic plan to avoid walking over partially laid floors with full boxes in the course of the work.



The floor was built up in the following worksteps:

- Measurement of the panel grid. Construction tolerances were absorbed with mineral fibre strips along the surrounding walls. Areas needing to be filled, e.g. around the supports, were partly filled with cut-up faulty VIP.
- Removal of sharp-edged unevenness and projections from the floor and along the joints to the walls. In practice it turns out that various 'disturbances' of this kind are present, which would not be expected from the plans and make it necessary to allow a basic tolerance along the edges in the laying plan. In the present case, for example, angle irons for fixing the windows were present and the lower guide rail of the sliding window was within the area for laying VIP, not as shown in the detailed drawing.
- Thorough cleaning of the floor with brush and vacuum cleaner, so that no small parts lie around which could be pressed into the VIP laminate.
- Laying of the protective mat, in this case a flexible PE foam layer.
- Laying of the VIP, pushed together in close contact. Bonding of the VIP panels with adhesive aluminium tape. This results in a solid group of panels which cannot move and simultaneously forms a continuous vapour barrier.
- Filling of the joint gaps and recesses with fibre insulation boards or in some cases with VIP remnants.
- Covering with flexible PE foam protective mat and laying of the covering panels. Covering is done continuously in order to protect the VIP layer as quickly as possible.



Figure 22: Worksteps in building up the floor



The essential worksteps in building up the ceiling are:

- The first layer consists of the wood laths with the VIP situated between. In order that the VIP are fitted tightly between the laths without being squeezed, it is of advantage to fix a lath, then adhere the first layer of VIP to the ceiling in close contact to the lath, then fix the next lath, etc.
- Installation of a second layer of cross-laths for the first layer of fibre insulation, 25 mm thick. The laths are screwed into the concrete ceiling at their points of intersection.
- Assembly of the third layer of laths with partial fibre insulation layer or conduits.
- Vapour barrier and gypsum boards with plastering.

Comment:

The floor was built up with VIP relatively quickly after careful preparation (laying plan, measurement, etc.). Problems arise because the VIP are rather exposed: it is not always possible to cover everything immediately with the walkable panels. During work breaks (lunch, night) there is a risk that the VIP will be walked on (the materials also attract inquisitive persons on the job). Objects may fall onto the VIP. Even if the work is done in socks, small, sharp-edged objects may stick to the socks. Particularly for the adhesion of the panels, one has to kneel around on them, causing dents that are not insignificant.

The ceiling structure presents the difficulty that a base must be mounted (laths) for fixing the ceiling suspension. Nevertheless, the use of VIP is rather easier since they are subjected neither to walking on nor to falling objects.

4.1.4 Costs, benefits, risks

The total price for the 2 cm thick VIP (material price incl. VAT) for the ceiling and floor of this 92 m² room was around 16'500 EUR. This yields an average price for the material of 89 EUR/m². Panels in special shapes and sizes cost 25% more than in the standard size (60 x 100 cm²).



4.2 Interior and dormer window insulation Refurbishment of property in Zürich/Switzerland

Location:

Nietengasse 20
CH-8004 Zürich

Architect:

Viridén + Partner
Andreas Büsser
Häringstrasse 20
CH-8001 Zürich

VIP: Vacucomp 30 mm

Execution: 2003



Figure 23: The refurbished property in Zurich

The main reason given for the use of VIP is space saving. This is particularly true in the present case because a very high standard of insulation, passive house standard, was aimed at. Furthermore, the architects' office hoped to gain a lead in know-how by 'trying out' innovative technology. Because of the use of VIP, the refurbishment was supported financially by the Federal Office of Energy as a pilot and demonstration project.

Comment:

Thanks to VIP technology, the problem of the dormer window was able to be solved in an aesthetically pleasing manner in spite of the passive house standard (relatively slim components). Indeed, for the architect, prefabrication is one of the most reasonable applications, since installation of VIP on site is too risky (lack of knowledge on the part of craftsmen, protection of material cannot really be assured). Moreover, particularly with interior insulation, many processes appear still to be improvised (joint sealing, complicated parts lists, matching



pieces) and important questions to be unsolved (condensation problems at beam head, climatic boundary conditions (humidity, temperature) for VIP).

All in all, routine and reliability are lacking for the use of VIP as interior insulation in refurbishment. Since the architect was also the owner, he was able to enter into the experiment. But his curiosity has been satisfied for the moment. A more promising application is seen in prefabricated dormer windows with VIP, which will be continued to be used in future.

4.2.1 Material and construction

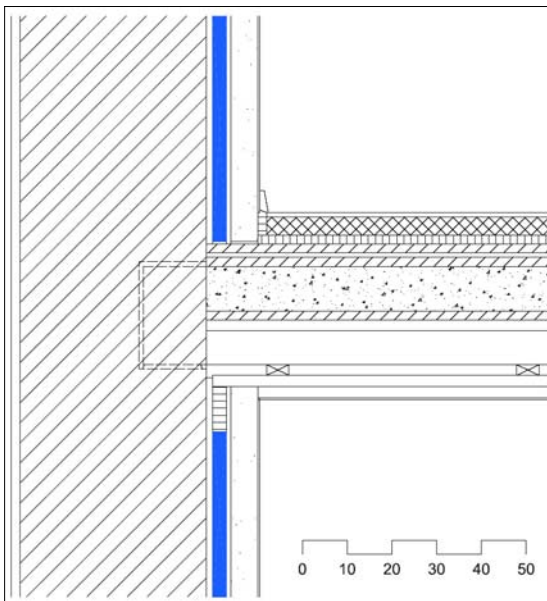

Wall structure

external rendering, existing	20 mm
quarry stone wall, existing	430 mm
interior plaster, existing	15 mm
VIP, new	30 mm
air gap	10 mm
solid gypsum board, new	60 mm
interior plaster, new	5 mm

Figure 24: Vertical section through the Brick outer wall with interior insulation

The VIP are bonded to existing interior plaster on the outer wall without joints. The tolerances are absorbed at the upper border with cork strips. In addition, this is a reaction to the thermal bridge. Cork can have a favourable influence on the humidity balance and ought to reduce the problem concerning the beam head.



Figure 25: Left: Interior VIP insulation with gypsum board walling in front
Right: Finished dormer window



In order to avoid penetration of the VIP layer with supports for the inner covering and to offer a certain protection against later damage on fixing shelves, etc., a free-standing wall consisting of solid gypsum boards was installed at a spacing of one centimetre from the VIP.

Dormer window

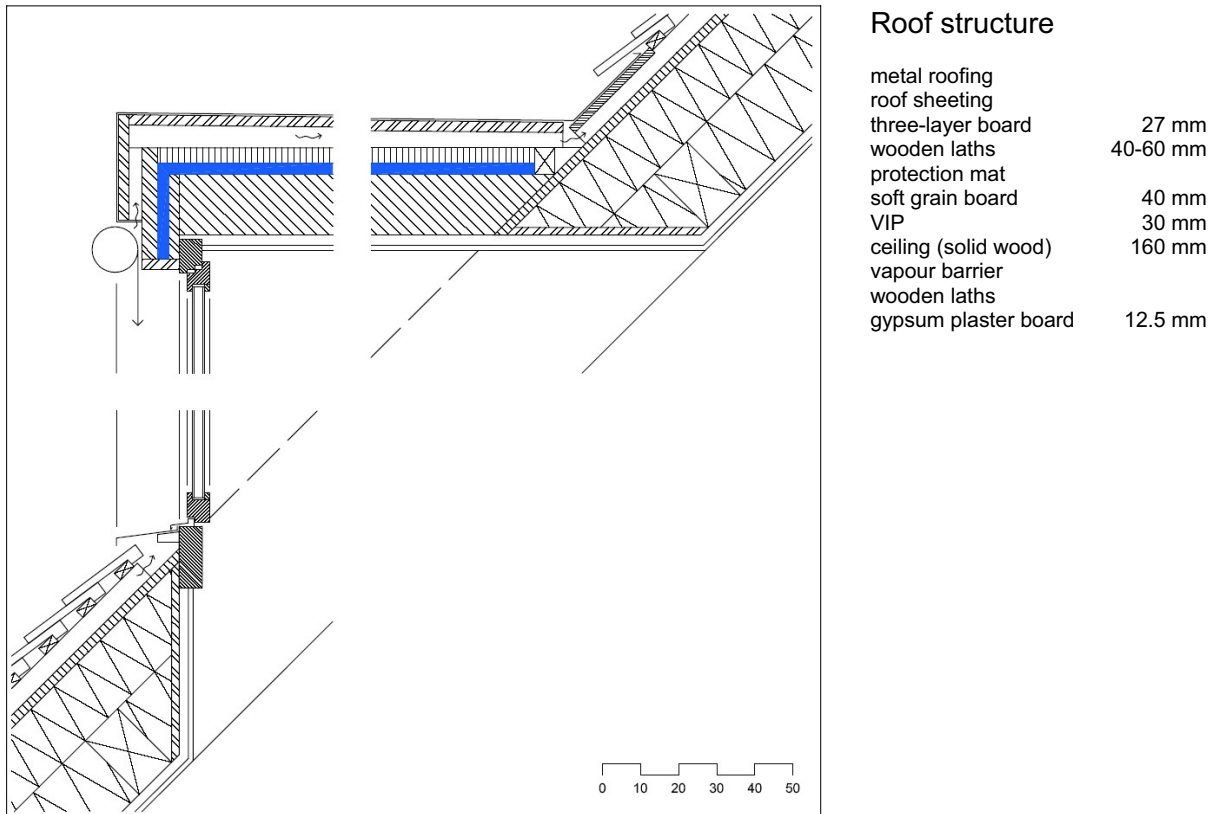

Figure 26: Section through the dormer window construction

In order that the VIP in the prefabricated dormer window construction are not interrupted by support structures, the weight of the roofing is transmitted via the cross-laths and face construction to the window frame. The VIP is protected from damage by the soft fibreboard.

Comment:

In the case of the interior insulation one notes the numerous different panel shapes and sizes and matching pieces. The construction sequence is still not harmonious enough and the bare VIP are left too long unprotected.

Prefabricated dormer windows appear to be a good application for VIP. The panels are installed under controlled conditions and are well protected from external influences (assembly, later worksteps).



4.2.2 Building physics and engineering

Thermal bridges and risk of condensation

The necessity of absorbing tolerances along the boundaries was made in this case into a virtue of building physics. Apart from the absorption of tolerances, the treatment of thermal bridges at joints to walls, ceilings and windows (incl. ledges, lintel and soffits) was a great challenge. As with the interior insulation, the thermal bridges are specially critical from the viewpoint of building physics. In contrast to systematic exterior insulation, in this case one has always to expect increased risk of condensation at the thermal bridges. The extremely high performance of the VIP only accentuates this problem. Here, the architect chose to use cork, which exhibits favourable properties with respect to humidity balance. But as a material with six to eight times poorer insulating properties than VIP, it also leads to weakening of the thermal bridge effect at the sensitive locations.

The joint to the ceiling is complex from the viewpoint of building physics. The wooden beam is supported in the exterior wall and in the joist ceiling there are cavities which provide the room humidity with easy access to the beam heads. In winter, the latter are significantly cooler after insulation and hence are exposed to increased risk of condensation.

The general risk of condensation is lowered in the present case by mechanical ventilation of the apartments.

Comment:

Interior insulation with VIP - to a slightly greater extent than with conventional materials - is subject to risks from the viewpoint of building physics. It hence requires comprehensive design optimization and conscious treatment of room humidity! It must also be said, however, that in many cases a 'high-risk' situation already existed in the original state in this respect (and very often no damage occurred). In old quarystone houses with a stove in each room, the surface temperature at thermal bridges (and at the beam heads) was well inside the critical range. This does not mean, however, that with interior insulation, one should not take all possible precautions to reduce these risks:

- *Flank insulation (insulating strips along joints to ceilings and walls): this is a good method but often not to be achieved at realistic expense and in a good design.*
- *Reduction of the insulation thickness along the thermal bridges: this leads to higher thermal loss, increasing somewhat the temperature at the critical points and hence lowering the risk of condensation.*
- *Surface materials with good humidity buffer behaviour: these do not reduce the frequency and amount of condensation, but they do reduce fungal attack.*
- *Cavities in ceilings, above all in the region of beam heads, should be stuffed (or filled by blowing). Specially suitable are cellulose fibre products, which form a relatively air-tight layer and have a good humidity buffer behaviour. In this way, the room air humidity can gain access to the external wall only by diffusion and no longer by convection. This drastically lowers the transport of humidity to the wall.*
- *Controlled ventilation of housing (often an integral part of the engineering concept in buildings to low energy standard) lowers the risk of condensation.*

Consequences of vacuum failure

Interior insulation: On failure of a VIP, the gypsum wall would have to be demolished, the faulty panel replaced and a new wall built in front (assuming one decides to replace it).



Although the insulation would drastically deteriorate locally on vacuum failure in a panel (increase in U-value from 0.22 to app. 0.46 W/(m²·K)), no new risks would arise from the aspect of building physics.

Dormer window: Additional layers assure that on VIP failure, the U-value would not rise above 0.27 W/(m²·K), thus minimizing risk of damage to the building.

Fixing problems and solutions.

Interior insulation: the VIP are adhered to the existing interior plaster. There is a question here of the compatibility of the VIP-laminate to the adhesive used.

4.2.3 Planning and execution procedure

The architect clarified the aspects of building physics in co-operation with a specialist. The supplier of the VIP was not invited to consult on building physics or construction. Co-operation with the supplier began only for the preparation of the parts list. He also specified the adhesive to be used for assembly. He informed and accompanied the craftsmen during assembly of the panels.

Comment:

The supervision by the VIP supplier is judged to be sufficient and absolutely necessary (above all, information on site).

4.2.4 Costs, benefits, risks

The small quantities and the many different sizes and shapes drove the costs up to an average level of 145 EUR/m² (incl. transport, special shapes and sizes, VAT). Furthermore, the planning effort was greater than when conventional insulation is used (scheduling, timing and supervision on site). Since the VIP must be protected (e.g. protective layer in the dormer window construction), further addition costs are to be expected.

The architects reacted to the insufficient warranty situation (only regular SIA terms are given) and the uncertainties regarding lifetime in different ways, depending on the component (see the chapter 'Consequences of vacuum failure').

Comment:

The high costs and the many uncertainties are regarded as the greatest problems. It would hence be helpful if estimates of lifetime were available as soon as possible (or even warranty periods?).



4.3 Terrace insulation Multifamily houses in Kerzers/Switzerland

Location:
Mühlegasse
CH-3210 Kerzers

Architect:
3-D Architekten AG
Peter Kunz
Murtenstrasse 13
CH-3210 Kerzers

Execution 2003



Figure 27: Terrace-like settlement on a gradual slope (left: photo; right: architect's vision)

All the terrace windows of one building were delivered too large, so that the planned terrace insulation (12 cm of polyurethane) could not be installed. Since one wanted to save the costs of new window production but had to maintain the planned thermal insulation, VIP was considered and finally used.

The overall assessment by the architect is quite positive. The use of VIP again in a further project (construction start in November 2003) is being evaluated.

Comment:

VIP is used here as an emergency measure. Architect and builder did not know of this material and became aware of its possibilities by accident. Terrace insulation is the most frequent application of VIP at present. Thanks to this routine and experience, the supplier was able to convert the initial scepticism of those involved into a positive assessment.



4.3.1 Material and construction

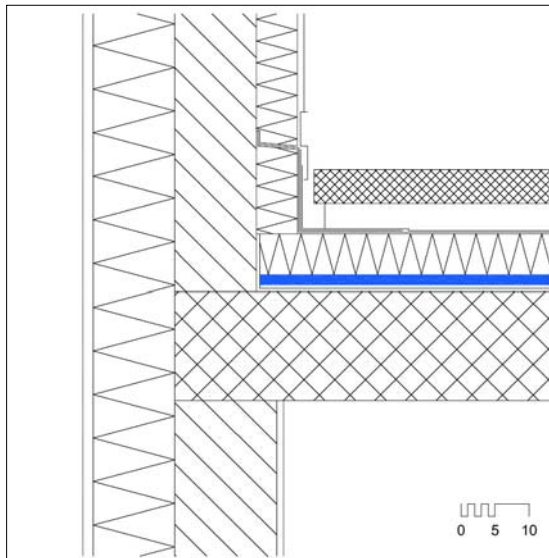

Floor structure

garden tiles	20 mm
stilted support (draining)	30 mm
PU slabs	60 mm
VIP	15 mm
PE foam mat	5 mm
seal	
concrete ceiling	200 mm

Figure 28: Vertical section through the joint detail at parapet

4.3.2 Building physics and engineering

Thermal bridges

The VIP supplier prepared an exact laying plan to enable the edge joints to be executed without matching pieces of conventional insulation, which could reduce the overall insulation value. The supports for the overhanging roof penetrate the insulation layer, which leads to local weak points. It is assumed that this will not cause condensation on the insides of the ceilings, since on the inside a sufficient heat flow through the concrete ceiling is assured.

Water vapour diffusion and material dampness

Various layers of the construction (concrete ceiling with sealing sheeting / VIP / drainage layer) are vapour barriers by themselves. It is not to be expected that condensation will occur in the construction.

The VIP are well protected on all sides. Apart from the mechanical protection measures (insulating mats or slabs), the water barrier layers, in particular, assure a perfect situation, optimal from the viewpoint of building physics as it is known today – no extreme temperatures, no penetration of moisture. However, proper assembly of the construction is a prerequisite, in particular that dry material be used and no rainwater enters in the course of assembly.

Consequences of vacuum failure

In the present case, an additional 60 mm of insulation material provides sufficient insulation in case of vacuum failure in order to minimize the risk of condensation. This part of the building would not, however, be adequate from the standpoint of energy conservation. On failure of the vacuum the U-value of the construction would deteriorate to $0.29 \text{ W}/(\text{m}^2\cdot\text{K})$.



Comment:

The additional insulation layers used in this situation are not the general rule with flat-roof or terrace insulation. They result in great difficulty should a faulty VIP have to be replaced.

4.3.3 Planning and execution procedure

The VIP supplier had a significant influence on the entire planning procedure specific to VIP. He worked closely with the architect and builders, starting with information for the planners (material properties, application possibilities, measures to be taken on site, etc.), preparation of the surveying, detail and laying plans, together with parts lists, information of the craftsmen involved on site and presence during execution. On site, one made sure that the VIP were protected as soon as possible from damage.

The VIP were laid on the polyethylene foam mat (Ethafoam) and the joints stuck down with adhesive aluminium tape. Almost in the same workstep, the additional insulation was laid, which minimized exposure of the VIP on site.



Figure 29: Building site – finished terrace: VIP is already well protected during installation.

Comment:

The early involvement of all concerned in matters specific to the VIP and the close co-operation of a person familiar with VIP technology during the entire process (incl. execution) has proven to be extremely valuable. The initial scepticism regarding dimensional precision, construction procedure and risk of damage was thus able to be counteracted, which at the end even led to enthusiasm for the possibilities of this new technology.

4.3.4 Costs, benefits, risks

At an average of 79 EUR/m² (incl. transport, special shapes and sizes, VAT), the material costs are considered to be the main handicap of VIP. Furthermore, the builder had to be reimbursed with the additional costs incurred by the use of VIP.

The chosen solution of the original problem was thus more expensive than supplying new windows.



If individual panels should fail, the water-bearing layer would have to be cut away locally, the panels replaced and a new water seal installed. The solution with stilted support / garden tiles provides optimal access to the water-bearing layer.

Comment:

The architect expressed the opinion that reliable estimates of lifetime (preferably with a corresponding warranty) ought to be made available as soon as possible. Although the supplier was asked several times, the architect had not at the time received a material-specific warranty. The warranty is based upon SIA terms, which in the opinion of owners is a far greater problem than the increased costs.

4.4 Floor insulation in a cold and deep-freeze room **Conversion of a shop in Winterthur/Switzerland**

Location:

COOP Center Grüze
Rudolf Diesel-Strasse 19
CH-8404 Winterthur

Planning and realization of vacuum insulation:

Schneider Dämmtechnik
Im Hölderli 26
CH-8405 Winterthur

VIP: VACUtex 20 or 40 mm in the floor construction



Figure 30: Building site of the floor insulation



The insulation regulations specify that with cold and deep-freeze rooms, the heat losses per square metre of building component shall not exceed 5 Watt (at 20 °C outside temperature). Especially with deep-freeze rooms, this leads to an insulation thickness of 30 to 40 cm, depending on the insulation material and temperature level of the room. This results in space problems, primarily when cold and deep-freeze rooms are retrofitted. The situation is usually especially delicate in the region of the floor. An additional, raised floor structure of this magnitude creates steps which are an extreme hindrance and removal of the uppermost layers of the existing floor does not usually suffice to avoid this (where at all possible). In these situations, VIP offers enormous benefits so that the material price of the VIP plays a secondary role in this application. Furthermore, expectations with regard to service life are not as high as with residential buildings. Cold and deep-freeze rooms do not remain in operation for longer than 15 to 20 years without modification. Operational changes, modification of product range or constructional/architectural remodelling usually lead to earlier replacement or demolition of such room cells. Lower expectation of service life also reduces the importance of the uncertainties and risk of failure of VIP. Cold and deep-freeze rooms were among the first applications of VIP in construction.

4.4.1 Material and construction

The underfloor must be flat (or flattened). Upon this, the first layer installed is the vapour barrier (Al 10 B). As a further precaution, a flexible PE foam sheet is rolled out, upon which the VIP is laid pushed tightly together. In order that the VIP not be damaged by walking on or by falling objects, a polyolefin sheet (roofing membrane) has been adhered to the upper face of each panel by the supplier in the exact size of the panel. The VIP layer is then covered with a 6 mm thick rubber meal mat, which also resists heavier 'attacks'. A separating layer (PE sheet) is laid and the 40 mm thick epoxy mortar walking floor poured. In the case of cold rooms (room temperature 2 to 10 °C), 2 cm thick VIP is installed. The VIP panels are laid starting from one edge and recessed into the opposite wall of the cold room (sheet metal-PU-sheet metal), whereby the gaps are filled with PU foam.

With deep-freeze rooms (-18 °C and below), the VIP is laid in two layers. Here, too, all the panels are protected on the upper face with polyolefine sheet. The panels are laid with the joints staggered by a minimum of 20 cm in order to minimize the effects of thermal bridges. In this case, the VIP layer is recessed into all the surrounding walls so as not to introduce thermal weaknesses in the edge region.

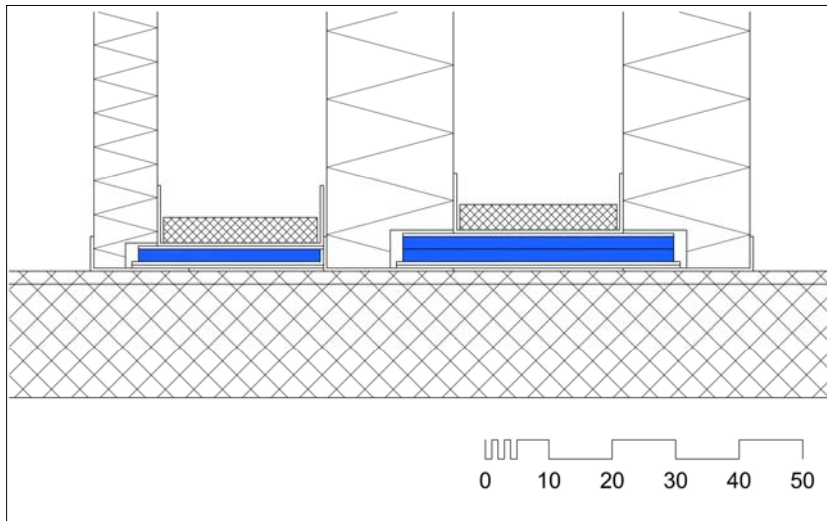

Floor structure

epoxy mortar	40 mm
separating layer (PE sheet)	
rubber meal mat	6 mm
polyolefin sheet	
VIP	20 / 2x20 mm
PE foam sheet	
vapour barrier	
ceiling	200 mm

Figure 31: Vertical section of a cold (left) and a deep-freeze room (right)

Thermal bridges

Heat bridges in the insulation layer are not permitted in deep-freeze rooms. In such rooms, door foldings, for example, where thermal weaknesses cannot be avoided, must be heated to prevent icing. In the case of cold rooms, mild thermal weaknesses, e.g. in the form of simple connecting details, are acceptable.

Water vapour diffusion and material dampness

The constructions of cold rooms and particularly deep-freeze rooms are vapour tight. The interior layer of the floor construction with its epoxy mortar is also vapour tight, although it would not have to be so for reasons of building physics. The vapour barrier necessary for this reason must lie on the exterior of the thermal insulation with cooled rooms (or the insulation can be itself vapour tight, e.g. foam glass). In contrast to residential buildings, with a cold room there is a permanent vapour pressure gradient and not a cycle of condensation and drying out. The vapour barriers used must hence be extremely tight. With VIP one assumes a very low migration of water vapour. According to the current state of knowledge, however, it is not expected that during the service life, ice will form inside the VIP on the side of the deep-freeze room.

Consequences of vacuum failure

With cold rooms, failure of the VIP will cause the U-value to rise dramatically to ca. $0.75 \text{ W}/(\text{m}^2 \cdot \text{K})$. Because of the small temperature differences, however, no negative effects are to be feared with the present construction from the aspect of building physics. Surprisingly, the risk of damage from vacuum failure in the VIP is not very high, even with deep-freeze rooms. Even if two VIP lying one above the other should fail, they still provide by far the greatest share of heat transmission resistance in the present construction, so that the temperature at the outer face of the VIP approaches quite closely the outside temperature and the condensation periods at the envelope foils are short (and drying can occur to the



exterior). Furthermore, the concrete slab acts as an efficient heat distributor which feeds heat to the cooled region and again lowers the risk of condensation.

Because of the jointless, high-quality mortar layer required for the flooring, replacement of a single VIP is not possible, or only at enormous expense.

4.4.2 Planning and execution procedure

Schneider Dämmtechnik executes the cold room insulation with VIP using their own craftsmen teams. This permits good instruction of the craftsmen and the experience from the work is retained for further projects. Detailed laying plans are drawn up. The areas are first filled with standard sized panels 100 x 50 cm². Then the necessary special shapes are worked out. Even quite complicated shapes are designed and ordered. As a general rule, no residual areas are tolerated that are filled with a replacement insulation (e.g. PU) that can be cut to size.

4.4.3 Costs, benefits, risks

Schneider Dämmtechnik works with VACUtex VIP. Each individual panel is provided with a sensor which allows measurement of the pressure as a final check. For this reason, the panels are more expensive than competing products. The square metre price for the 2 cm thick panel in the standard size is 107 EUR.



4.5 Non-load bearing wall sandwich elements Single-family house in Landschlacht/Switzerland

Location:

Oberer Seeweg 9
CH-8597 Landschlacht/TG

Architect:

Architecturbüro Beat Consoni
Pestalozzistr. 38
CH-9400 Rorschach/SG

Other participants:

VIP supplier: SAES Italy (Microtherm)
Manufacturer of the wall elements: NIKOL MULTIPLAC, CH-5412 Gebenstorf
Metal construction engineer: Reto Gloor, Guntershausen, www.mbtgloor.ch
Building physics: IPG Keller, Kreuzlingen

Year of construction 2003



Figure 32: Single-family house with VIP-Multiplac wall elements

During preparation of the official certificate of insulation, the participants found that to compensate for the high percentage of glass in the façade, additional insulation would have to be installed in the latter. On the other hand, the architect wanted as thin an outer wall as possible because of the narrow building perimeter. He was therefore prepared to employ a new material technology. These official and architectural constraints led to a novel design of wall structure, a VIP warm façade. The modern, strictly cubic building is a success and the participants are satisfied with the installation of the eight VIP wall elements on the ground floor with an area of about 50 m².

Comment:

The demand for low-thickness building components is widespread and encourages the



examination of design variants incorporating VIP. In the present case, a satisfactory novel solution was able to be implemented thanks to the competence and motivation of the participating planners and firms.

4.5.1 Material and construction

In the present project, eight façade elements were executed as a warm façade using NIKOL-MULTIPLAC sandwich panels. These were installed in front of a metal frame. On the inside, a six centimetre thick mineral wool slab was installed and covered with two gypsum plaster boards.

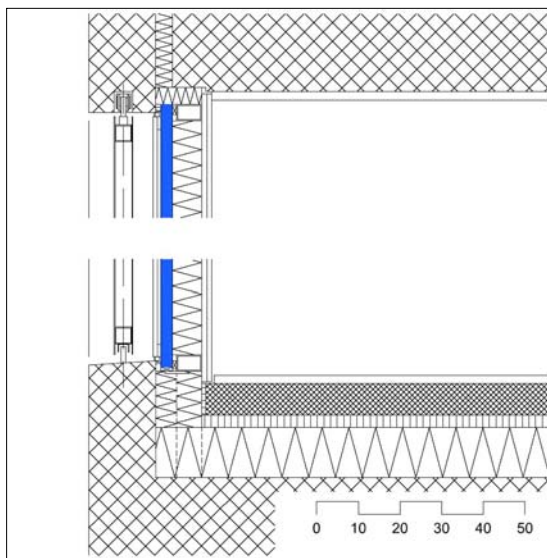

Wall structure

gypsum plaster board	2x12.5 mm
mineral wool	60 mm
sheet steel, hot-galvanized	1.5 mm
Microtherm VIP element	25 mm
sheet aluminium, clear anodised	2 mm
air gap and adhesive	1 mm
glass with black layer behind	6 mm

rear ventilation up to one-storey high, movable, sliding sandwich panel providing glare and sun protection and lightcontrol 20 mm

Edge band: Acquacombi (recycled polyurethane mixed with thermoplasts and additives; thermal conductivity 0.073 W/(m·K))

Figure 33: Section of façade with VIP-Multiplac wall elements

Comment:

The EMPA published the recommendation that to avoid worsening of the thermal bridge effect, VIP should not be in direct contact with metal boarding. To comply with this recommendation, the NIKOL company now installs an additional PVC panel or a fleece layer on both sides of the VIP. At the time of the detail planning, special protection of the VIP in the sandwich was not considered. The façade has one-storey-high sliding elements which in the rest position stand exactly in front of the VIP sandwiches. The façade elements are not unduly exposed to the sun since the upper storey overhangs on both sides and also provides shading. The effect of sunshine on the glass, which is backed by a black layer and adhered to the façade element, is uncertain. On the one hand the mass of the glass acts as protection but on the other hand, the black paint tends to cause overheating. The VIP are in direct contact with the metal boarding and hence exposed to the effect of a continually varying temperature, which could lead to increased degradation. No calculations or simulations were made concerning these physical phenomena.



Figure 34: Façade detail with sliding elements in rest position in front of VIP wall elements

In the case of the VIP used (from SAES), a number of characteristics must be observed that limit applications in construction:

- Limited panel size: the maximum dimensions available ($60 \times 120 \text{ cm}^2$) are small. Joining together many small VIP panels to form large dimensions is unfavourable with regard to thermal insulation.
- Precision: the tolerances to be taken into account of $\pm 6 \text{ mm}$ are large. The edge region must be generously dimensioned and filled with insulation that is inferior to VIP. Fitting into the frame requires careful manual work.
- Delivery: small numbers of pieces of different sizes are not very interesting for the Italian producer and can lead to delays in delivery.

4.5.2 Building physics and engineering

Thermal bridges

The sandwich panels are fitted onto a metal beam between the steel posts, adhered and sealed on both sides with adhesive aluminium tape so as to be air and water vapour tight. The edge joint consisting of 2 cm thick recycled PU foam (Acquacombi) represents the thermally weakest part of the sandwich ($\lambda = 0.073 \text{ W}/(\text{m}\cdot\text{K})$). The filling material for the rest of the area is cut from polyurethane, aluminium coated on both faces, and inserted. On the outside of the sandwich in front of the glass cover (10 mm) there is an air gap (8 mm). On the room side, 6 cm of mineral insulation covers the entire construction. We are dealing here with a detail that is demanding from the aspects of design and execution, exhibiting serious thermal bridges at the base of the supports. No calculations of thermal bridges were made.



Water vapour diffusion and material dampness

The NIKOL-MULTIPLAC sandwich panels are stuck together with materials that are completely insensitive to moisture, the bond being water resistant, and are effective barriers to air and water vapour diffusion. After installation, the VIP were sealed on both sides with adhesive aluminium tape so as to be air and vapour tight.

Consequences of vacuum failure

The VIP are in direct contact on both faces with the metal boarding of the sandwich panel (aluminium and galvanized sheet steel). After large, repeated temperature swings, the service life of the VIP might be reduced. In case of vacuum failure, the U-value of the wall construction would not deteriorate to an impermissible value thanks to the 60 mm of mineral wool insulation ($U = 0.33 \text{ W}/(\text{m}^2 \cdot \text{K})$), so that the overall insulation would not drop below the minimum value from the aspect of building physics (risk of condensation).

4.5.3 Planning and execution procedure

The architect developed the detail together with the metal construction engineer, who also prepared the submission documents with all specifications of dimensions. The execution planning was carried out by the metal constructor and the execution plans and production supervision were done by NIKOL MULTIPLAC. On arrival in the metalworking shop, the sandwich elements were marked with 'Caution' signs, put in intermediate storage and transported to the building site for installation only when required.

There was no exchange of further information between the participants regarding the handling of the VIP sandwich elements.

4.5.4 Costs, benefits, risks

The VIP sandwich elements cost about 200-230 EUR/m², a total of 16-18'500 EUR for the 80 m².

NIKOL MULTIPLAC grants the normal warranty periods according to Swiss Obligatory Law and SIA. To date no warranty claims have been lodged. There exist no special warranty agreements with the Italian VIP producer SAES.

Comment:

In the case of VIP we are dealing with a novel insulation material which is manufactured abroad, is being continually improved and with which the participants were not yet able to gather much experience. For these reasons, it is strongly advisable to form a good specialist team when using VIP and to thoroughly discuss and clarify all problems and risks concerning design, material technology and building physics.

Suitable precautions should be taken in case of VIP failure (e.g. minimum insulation (no risk of condensation) and room comfort should be assured, exchange of panels should be simple, etc.).



4.5.5 Supplement

The NIKOL MULTIPLAC sandwich elements are available in various versions and in sizes to order. VIP may be installed in one or two layers. They are protected by additional thin PU layers or rigid PVC sheets. The outer and inner cover layers are made of sheet metal, plastic or wood.

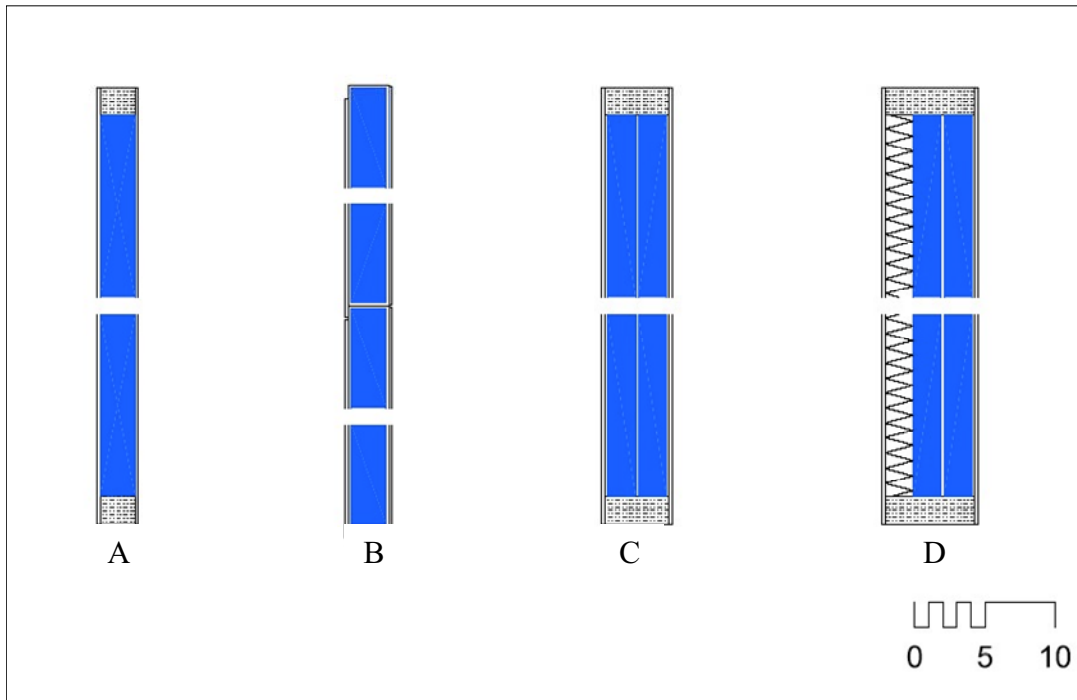

Figure 35: VIP-MULTIPLAC elements

A for post-and-beam façade systems

B for outdoor applications

C, D with increased insulation and protection against high temperature



4.6 Parapet insulation in window element

Apartment conversion in a multifamily house in Basel/Switzerland

Location:

Hagentalerstr. 53
CH-4053 Basel

Building promotor:

Judith Bucher, Basel

Building planner and physicist:

Franco Fregnan, Basel
www.fregnan.ch

VIP: Vacucomp 30 mm in the window parapet of a window element, ZZWancor



Figure 36: Window element with tight-fitting VIP

One of the two balcony doors was removed and replaced by a window element. The parapet part of this element was designed as a frame enlargement and attached to the structure. In the region of the parapet, the kitchen construction is adjacent to the element on the inside.

Comment:

This building component is well suited for installation of VIP. For components such as window parapets or frame enlargements, which have a certain size, are not complicated in design and have a low risk of damage during installation and service, VIP is highly suitable.



4.6.1 Material and construction

The parapet part of the window element was designed as a frame enlargement and attached to the structure.

The original intention to install the VIP on the inside of the parapet was abandoned because of a delay in delivery of the VIP: it would have been difficult to install it behind the kitchen combination after the kitchen was finished. The VIP (586 x 588 x 30 mm³) was installed from the balcony side and the parapet was closed off with screwed-on boarding.

Comment:

One should make sure that the VIP panel can still be installed after a delay, e.g. in delivery. The design should also take into account possible replacement of panels at a later date.

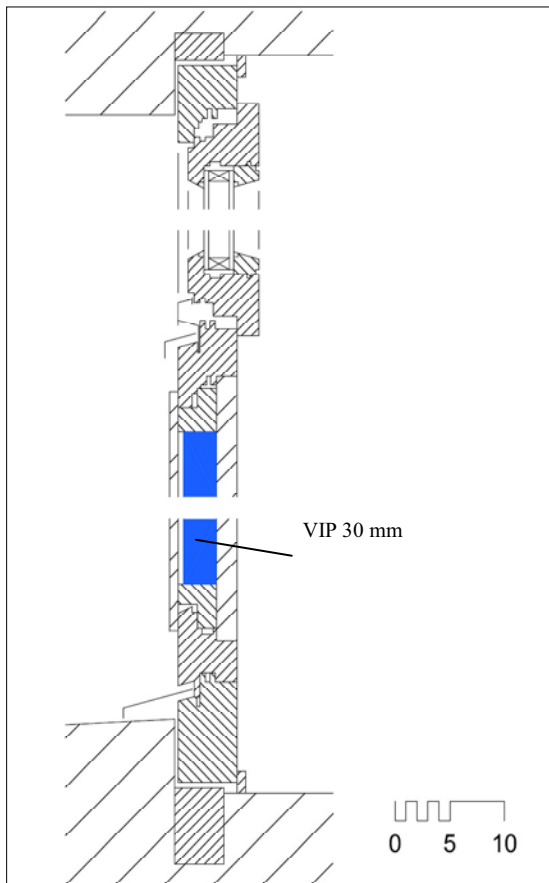

Figure 37: Parapet with VIP

4.6.2 Building physics and engineering

Thermal bridges

In the present case, the VIP is in direct contact with the wood profiles of the frame widening. It was ordered to fit exactly and was able to be inserted under slight pressure in the parapet recess. The edge region did not have to be filled. There are no serious thermal bridges. The influence of the edge region of the VIP on the insulation value was not investigated.



Water vapour diffusion and material dampness

The inner parapet boarding was glued so as to be waterproof and is hence more air-tight and also somewhat more vapour-tight than the outer, screwed boarding. There should be no problems and risks with regard to moisture.

Consequences of vacuum failure

If the vacuum should fail, the insulation resistance of the supporting structure would still be better than that of the insulation used in commercial frame enlargements. The U-value would then be 0.7 instead of 0.30 W/(m²·K), i.e. still better than a normal frame enlargement (U-value ca. 1.0 W/(m²·K)), but already in the range of a critical component from the aspects of energy conservation and building physics.

4.6.3 Planning and execution procedure

The building planners developed the detail in cooperation with the window manufacturer, who ordered the panel from the VIP supplier. The planner stipulated that he be informed before installation and be present during this operation for the purposes of documentation and quality surveillance.

Delivery and installation of the VIP took place without special precautions. For a moment, those present thought the VIP to be too large to fit in the frame. But with slight pressure they succeeded in bringing the VIP into the desired position. Nothing can be said about the stressing of the foil which occurred on overcoming the resistance to insertion.

Comment:

VIP should rather be ordered too small than to exact size. For installation with exact fit, suitable filling material must be at hand.

Planning information should be requested from the VIP manufacturers and dealers in which data on the mean heat transmission are given in dependence on the dimensions of the VIP.

4.6.4 Costs, benefits, risks

The extra cost of ca.130 EUR for the parapet (corresponding to a square metre price of 380 EUR) was judged to be of secondary importance. The fact was highly valued that with little effort, an innovative, future-oriented material was able to be used and a problematic component made harmless from the standpoints of energy conservation and building physics. A detailed cost/benefit study was not made.

No special warranty agreements were made.

Thanks to the VIP, an innovative feature was added to the conversion. All participants welcomed an opportunity to gain experience with this new material and would use it again in future.



4.7 Façade insulation with prefabricated panels Terraced houses in Binningen/Switzerland

Location:

Kirchweg/Florastrasse
CH-4102 Binningen/BL

Architect:

Feiner Pestalozzi
Bärenfelsenstrasse 21
CH-4057 Basel/BS

Façade system: Häring AG

VIP supplier: lambdasave GmbH

Year of construction

2005

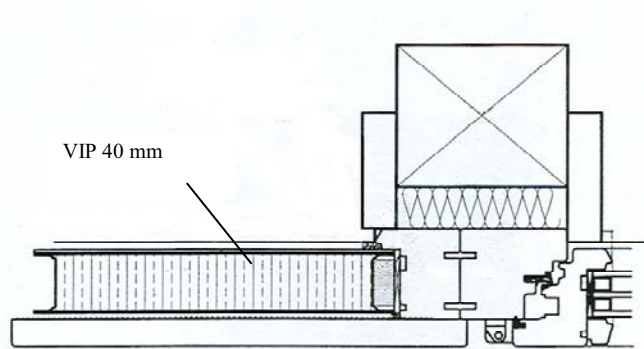

Figure 38: Left: Horizontal section through the construction
Right: Installation of the VIP

On the north and south façades of the five terraced houses, which are of wooden construction, VIP one storey high (ca. $2.60 \times 1.60 \text{ m}^2$) are installed in a wooden window frame construction. The VIP from lambdasave consist of a nano-structured support core in stainless steel trays ($>0.5 \text{ mm}$) sealed by welding at the edges with thin special profile of stainless steel. Panel thicknesses of 15, 30 and 40 mm are available in the dimensions from $0.50 \times 0.50 \text{ m}^2$ to $3.00 \times 8.00 \text{ m}^2$. The VIP used in this project ($d = 40 \text{ mm}$) have a U-value of $0.14 \text{ W}/(\text{m}^2 \cdot \text{K})$ in the centre of the panel, according to the manufacturer, without considering the losses at the edge seals and the frame construction. For aesthetic reasons, the panels are provided with an additional metal facing on the outside. On the inside a wooden covering layer is installed. Repair of the VIP at a later date is possible by welding the damaged location and subsequent re-evacuation. The cost of the entire façade system amounts to ca. $300 \text{ EUR}/\text{m}^2$.



4.8 Façade insulation

Renovation of a semi-detached house in Nuernberg/Germany

Construction:

Schnös Trockenbau, Knetzgau, Germany

VIP-product:

WACKER CHEMIE GmbH, Kempten, Germany

Date of realization:

November 2000

Funding:

Bavarian State Ministry for Economics, Infrastructure, Transport and Technology



Figure 39: Photograph of the house before and after the gable was insulated

For an old building the German Federal Department for Preservation of Historical Monuments ordered a limit of 6 cm for the thermal insulation, because the eaves were very small at the gable side. To fulfil this requirement a composite system with 15 mm vacuum insulation panels was used. The façade also had to be replastered. The comparison of the pictures before and after renovation (Figure 39) shows that the house has visually remained virtually unaltered.

4.8.1 Material and construction

The 15 mm thick VIP ($0.5 \times 0.5 \text{ m}^2$) were mounted into horizontal plastic rails and were covered with 35 mm polystyrene boards before the plaster was applied. The VIP and the polystyrene boards were fixed with a small amount of adhesive. The U-value of the wall (30 cm thick wall made of natural stone) was improved from 0.6-0.75 $\text{W}/(\text{m}^2\cdot\text{K})$ to 0.19 $\text{W}/(\text{m}^2\cdot\text{K})$. The 'Vakudämm' system can also be used to internally insulate walls. Figure 40 shows the cross-section of the insulated wall and Figure 41 a photograph of the gable during installation. Triangular VIP had to be installed in the gable. Some small VIP measuring $25 \times 50 \text{ cm}^2$ and $12.5 \times 50 \text{ cm}^2$ were installed near the windows. 95% of the area is therefore



insulated with VIP and only 5% merely with polystyrene. The surface area of the gable was about 35 m².

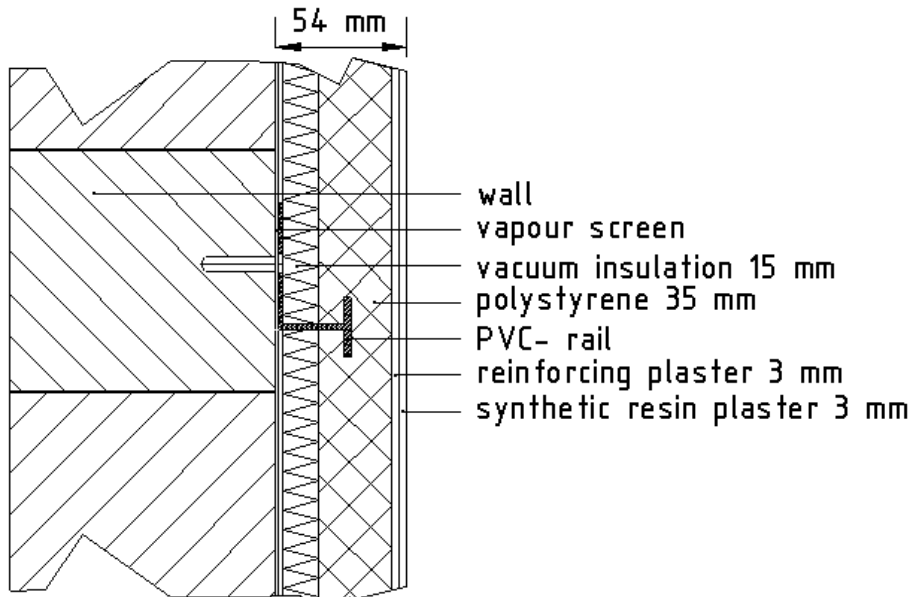

Figure 40: Cross-section of the insulated wall



Figure 41: Gable during installation. The shiny VIP are already in the rail system. The pale pink polystyrene boards are being mounted.

4.8.2 Building physics and engineering

The plastic rail simplified mounting the VIP and the plastic rails only cause small thermal bridges. A barrier foil was installed between the wall and VIP to stop vapour. There were no problems mounting the VIP. Even if the vacuum fails, the wall will be insulated because the thermal conductivity of the aerated VIP is only 0.02 W/(m·K) and the layer of polystyrene provides extra insulation. The U-value of the wall construction would deteriorate from 0.19 to 0.32 W/(m²·K).



4.8.3 Planning and execution procedure

The construction was developed by Hermann Schnös, who is a qualified painter and plasterer. He installed the construction personally. It was difficult to carry the single VIP from the pallet over the scaffolding to the rails. It would have been more efficient to carry the VIP with a hood. The edges of the foil cause gaps between 2 and 4 mm, but there are no gaps between the polystyrene boards.

The Bavarian Center for Applied Energy Research, ZAE Bayern, supported the project by calculating vapour and heat transport in the wall. Infra-red images have been taken each year to monitor the homogeneity of the insulation. The infra-red image taken in 2003 can be seen in Figure 42. The temperature difference between the edges and centres of the VIP is about 0.7 K. Not one aerated VIP has been detected in the last three years. The plaster has not cracked or changed in colour.

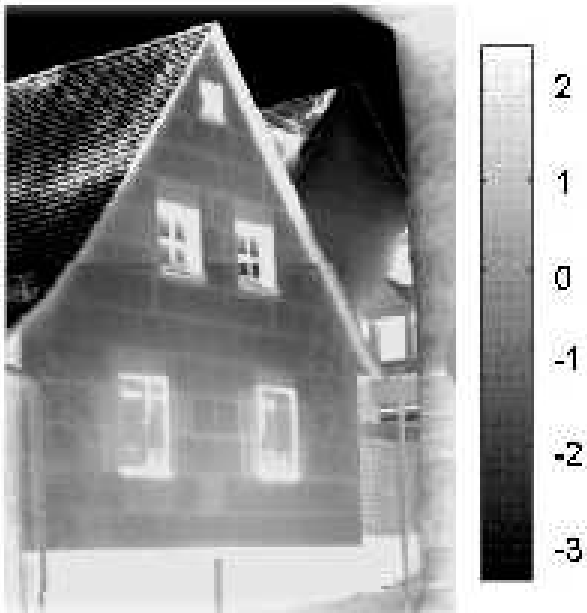

Figure 42: Infra-red image (from 2003) of the gable façade three years after the external thermal insulation composite system was installed. The edges of the VIP can be seen as lines (thermal bridges).

4.8.4 Costs, benefits, risks

The advantage of this construction is the rail mounting system. There is no danger of damage to the VIP and the rails only cause small thermal bridges.

Even if the vacuum fails, the wall will be insulated because the thermal conductivity of the aerated VIP is only $0.02 \text{ W}/(\text{m}\cdot\text{K})$ and the layer of polystyrene provides extra insulation.



4.9 Insulation of outside walls, roof and door

A new semi-detached wooden house in Munich/Germany

Planning and execution supervision:

Lichtblau architects

Munich, Germany

Florian Lichtblau

lichtblau-fw@t-online.de

VIP-Product:

WACKER CHEMIE GmbH, Kempten, Germany

Date of realization:

January 2002

Funding:

Bavarian State Ministry for Economics, Infrastructure, Transport and Technology



Figure 43: Left: South view of the house.
Vertical collectors are integrated between the French windows
Right: North-east view of the house

A solid-wood, lowest-energy semi-detached house was built in Munich whereby the highly-efficient insulation was realized with slim and architecturally high-grade constructions.

4.9.1 Material and construction

The construction permits defect VIP to be replaced. The U-value of the wall, which has a total thickness of less than 20 cm, is only $0.14 \text{ W}/(\text{m}^2\cdot\text{K})$. VIP were also integrated in the roof and the front door. A lowest-energy house should be built incorporating adjustable ventilation with geothermal energy exchange and heat recovery as well as a solar absorber for heating and warm water. The heating demand is about $20 \text{ kWh}/(\text{m}^2\cdot\text{a})$ and the primary energy consumption is lower than $50 \text{ kWh}/(\text{m}^2\cdot\text{a})$.

To minimize thermal bridges it was necessary to use customized VIP. Figure 44 depicts the wall construction of the north wall. The majority of VIP measured $100 \times 105 \times 4 \text{ cm}^3$. Figure 45 shows the VIP being installed into the lath construction. The laths are mounted onto the



8 cm thick wall made of solid wood. Solar absorbers were installed in the south wall with two layers of 15 mm thick VIP behind the solar absorber.

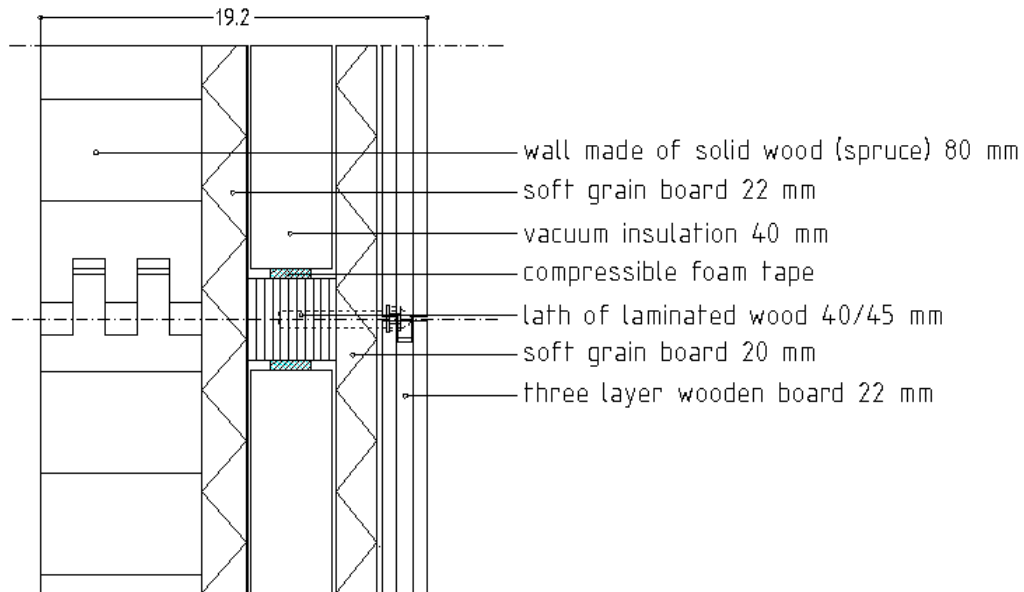

Figure 44: Cross-section of the northern wall



Figure 45: Installation of the VIP into the lath construction



4.9.2 Building physics and engineering

The Bavarian Center for Applied Energy Research, ZAE Bayern, supported the project by calculating vapour and heat transport in the wall. Infra-red images were taken to monitor the homogeneity of the insulation. The infra-red image can be seen in Figure 46. A non-insulated old house can be seen in the background. The thermal bridges of the wooden substructure can be clearly recognized.

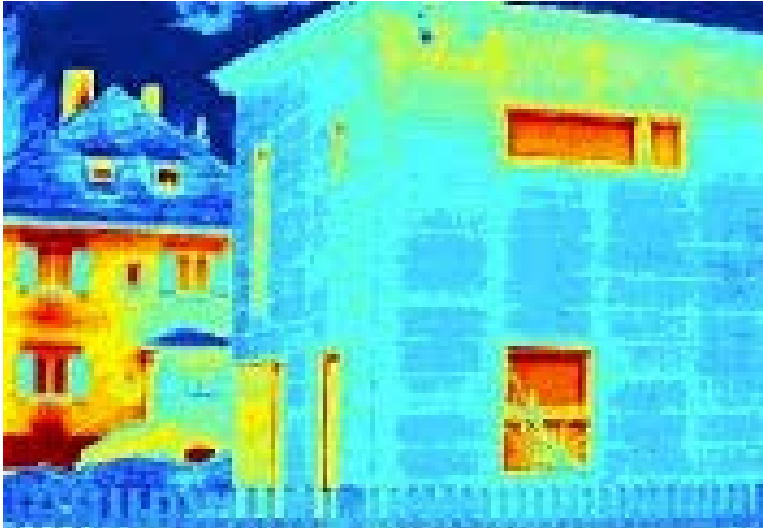

Figure 46: Infra-red image of the north-east corner of the building

The main advantage of this construction is that the VIP can be replaced. The disadvantage is the thermal bridges caused by the reverse laths. The internal area of the house is 15 m² larger than it would have been if conventional insulation had been used. On failure of the vacuum the U-value of the wall construction would deteriorate from 0.14 to 0.29 W/(m²·K).

4.9.3 Planning and execution procedure

The construction was developed by Lichtblau architects and the insulation was monitored by the Bavarian Center for Applied Energy Research, ZAE Bayern. Work was supervised and managed by Lichtblau architects. The VIP had to be made in very precise sizes as the compressible adhesive tape used to joint them only compensates for small gaps. The VIP had to be produced with a precision of ± 5 mm. If panels are too large, they cannot be integrated. The size was also influenced by the folds at the edges of the foil. These gaps are greater for thicker panels. Aerated VIP were mostly recognized due to loose foil at the corners. If the hole is very small, the damage cannot be recognized before installation. In future, protection at the corners in particular should be planned. Testing at the construction site would be a great advantage.

4.9.4 Costs, benefits, risks

Lichtblau architects are interested in building more houses with vacuum insulation. A prerequisite is that a solution to the warranty problem can be found. Several architects and house-owners who have seen the house have expressed high interest in vacuum insulation.



4.10 Insulation of the building envelope

Complete renewal of a terraced house in Munich/Germany

Planning and execution supervision:
Lichtblau architects, Munich, Germany

Contact:
Florian Lichtblau, lichtblau-fw@t-online.de

VIP-product:
WACKER CHEMIE GmbH, Kempten, Germany

Funding:
Bavarian State Ministry for Economics, Infrastructure, Transport and Technology



Figure 47: South and north façade after renovation

The aim was to convert a house built in 1956 into a lowest energy house. If conventional insulation had been used, the insulation would have been 20 cm thick. Vacuum insulation was used to ensure a thermal covering in a slim and lightweight execution. It was important to minimize the projection of the façade due to the neighbouring houses.

Figure 47 on the left shows the south façade of the house after renovation. Completely integrated solar absorbers under prism glass, held by steel retainers can be recognised in the façade, yet only the black colour points to the technical use. Because of the drainpipes, the transition between the insulated house and the non-insulated neighbouring houses can hardly be recognized. This was only possible with the slim, vacuum-insulated construction. Figure 47 on the right shows the north view. You can see the cement fibreglass plates and the steel profiles, with which the façade plates are fixed.



4.10.1 Material and construction

The original wall was made of 34 cm thick bricks and plaster. Figure 48 shows the cross-section of the wall at the north side and Figure 49 that of the south wall after renovation. Two layers of VIP were installed to minimize the influence of the laths, which cause thermal bridges. New windows were installed in the insulation layer.

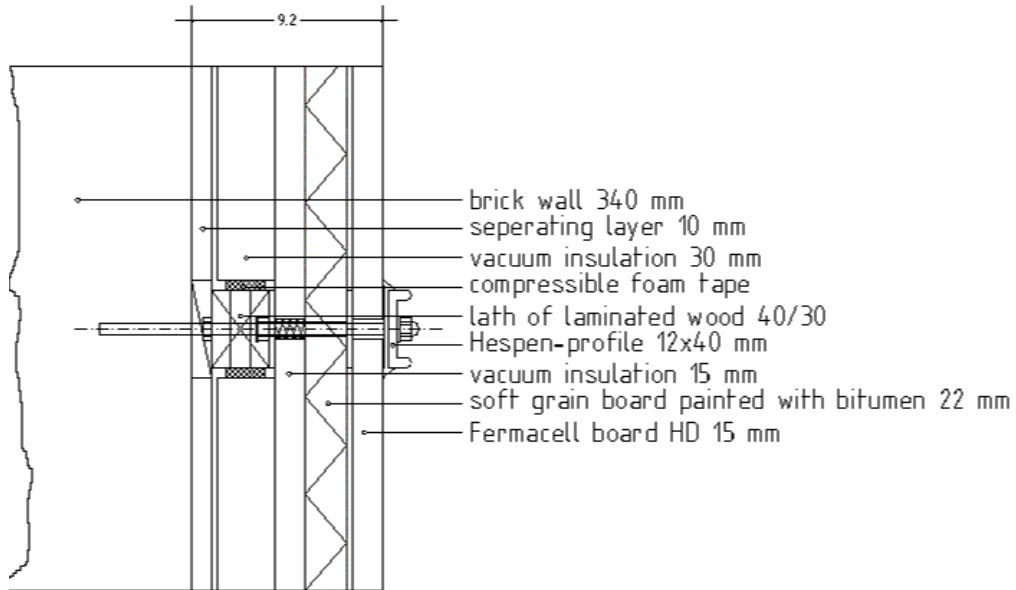

Figure 48: Cross-section of the northern wall

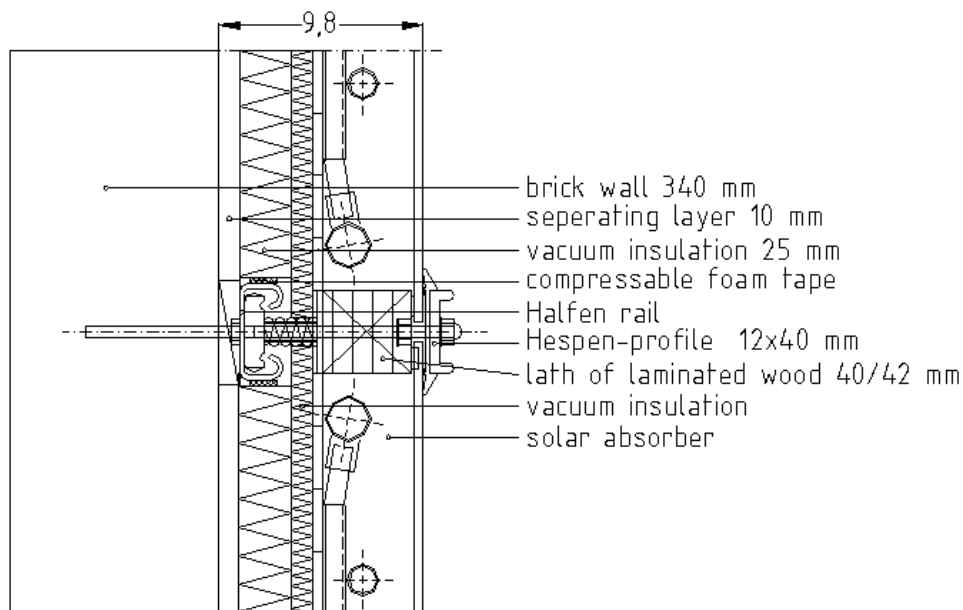

Figure 49: Cross-section of the south wall



4.10.2 Building physics and engineering

The Bavarian Center for Applied Energy Research, ZAE Bayern, supported the project by calculating vapour and heat transport in the wall. Infra-red images have been made each year to monitor the homogeneity of the insulation. The infra-red images made in 2002 and 2003 can be seen in Figure 50.



Figure 50: Infra-red images of the north side of the building
On the left: 2002, on the right: 2003

The horizontal white lines are caused by the steel profiles. The weak, vertical lines are caused by the edges of the VIP. In 2002, all VIP were still evacuated, but in 2003, one VIP on the left side of the door seems to be filled with air. The 2003 image shows a part of the neighbouring house on the right. The difference in colour shows the effectiveness of the insulation.

The U-value of the northern wall is $0.155 \text{ W}/(\text{m}^2\cdot\text{K})$ for a total construction thickness of 9.2 cm (40 mm VIP). The U-value of the south wall is $0.19 \text{ W}/(\text{m}^2\cdot\text{K})$ for a total construction thickness of 9.8 cm. The thermal bridges here were stronger, because it was necessary to use steel retainers for the absorbers and the VIP thickness was only 35 mm. On failure of the vacuum the U-value of the northern wall construction would deteriorate from 0.155 to $0.28 \text{ W}/(\text{m}^2\cdot\text{K})$, of the southern wall construction from 0.19 to $0.33 \text{ W}/(\text{m}^2\cdot\text{K})$.

The VIP were also used as slim additional insulation in the roof and the cellar ceiling. A lattice of laths was screwed to the ceiling and the VIP were fixed to the laths with tape. Wooden boards were subsequently screwed to the laths. The U-value was reduced to $0.26 \text{ W}/(\text{m}^2\cdot\text{K})$ for a total insulation thickness of 3.5 cm. The numerous pipes mounted on the ceiling were somewhat problematic – a large quantity of polystyrene had to be used to fill holes; VIP are nevertheless a good solution to insulate low-ceilinged cellars.

The total heating energy demand was reduced by a factor of 10!



4.10.3 Planning and execution procedure

The construction was developed by Lichtblau architects. The VIP were produced by WACKER CERAMICS. The Bavarian Center for Applied Energy Research, ZAE Bayern supported the project by calculating vapour and heat transport in the wall. Work was supervised and managed by Lichtblau architects. Numerous customized VIP had to be specially made for this project.

The plans for the south wall indicated that solar absorbers were to be mounted directly onto the VIP. This could have caused damage to the vacuum in the VIP because high temperatures are to be expected on the back of the absorber. Tests were therefore carried out with three different solar absorbers, whereby the temperatures were measured. The maximum VIP temperatures were between 116 °C and 161 °C and reached the highest values when the solar absorber was not working. The VIP were filled with air after 6 weeks. Another test was carried out with a 5 mm fleece between the absorber and the VIP. The temperatures dropped by about 25 °C and the VIP worked without sustaining damage for 10 months. To take precautions in case of vacuum failure, the total 30 mm thick VIP layer was divided into two VIP 15 mm thick: if one VIP is damaged, the other continues to insulate.

4.10.4 Costs, benefits, risks

The benefits are:

- Best insulation with slim, lightweight construction
- Discreet transition to the neighbouring houses
- The height of the roof remained unaltered
- Slim additional insulation in the roof and the cellar
- If VIP are damaged, they can be replaced

Drawbacks:

- The real size of the VIP varied greatly
- Handling unprotected VIP increases the risk of damage
- Why the VIP became filled with air is unclear
- Minor damage to the VIP could cause them to very slowly fill with air – the damage could easily go unrecognized
- Producing customized VIP is expensive and they cannot be subsequently altered if the measurements are incorrect.



4.11 Insulation of a wall heating system Renovation of a former church in Wernfeld/Germany

Construction:

Architect Werner Haase, Karlstadt, Germany

VIP-product:

va-Q-tec AG, Würzburg, Germany

Date of realization:

May 2003

Funding:

Bavarian State Ministry for Economics, Infrastructure, Transport and Technology

A wall heating system had to be installed in the former church in Wernfeld / Main (Germany). The church was built in 1612 and was renovated for use as a multi-cultural, multipurpose community hall. Thick, conventional insulation was not permitted as the building is classified as an historical monument. Nevertheless, efficient insulation was necessary to reduce the heat loss through the solid natural stone wall ($\lambda = 2 \text{ W}/(\text{m}\cdot\text{K})$) and to achieve a comfortable temperature inside. The concept of low heating demand assumes that the temperature in the church hall is as low as possible. Nevertheless, the user ought to feel comfortable and the heat must be provided and sustained where the users need it. This aim was achieved by combining ventilation heating and wall heating. Vacuum insulation was an ideal solution for the walls. A slim wall heating system was installed using the vacuum insulation which not only reduces the heat loss through the wall, but also radiates a comfortable amount of heat into the area used. The roof, windows and floor were renovated with conventional insulation.

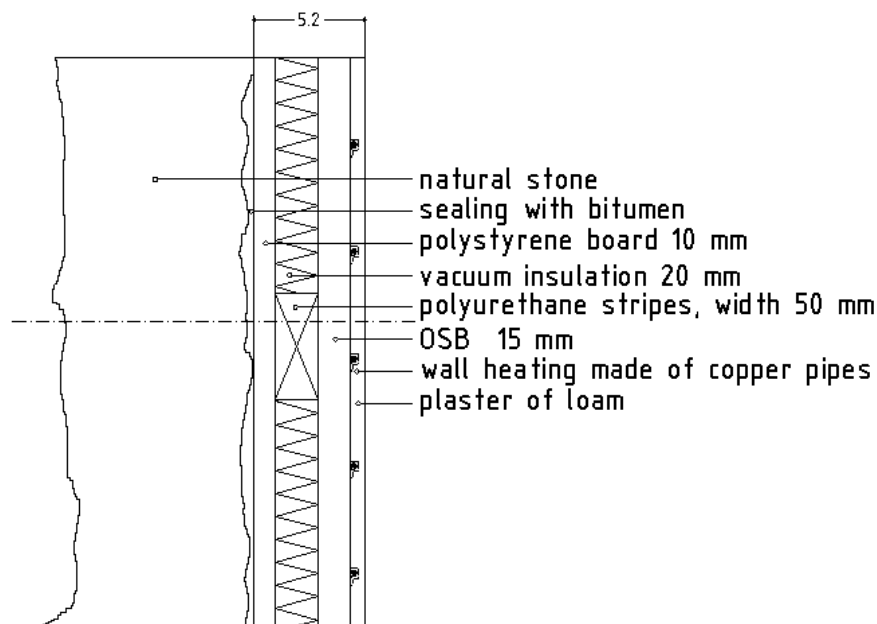

Figure 51: Cross-section of the wall



4.11.1 Material and construction

Figure 51 shows the cross-section of the renovated wall. VIP measuring $0.5 \times 1.0 \text{ m}^2$ were mounted onto polystyrene boards with dispersion based mortar. 5 cm high polyurethane strips were installed between the rows of VIP. Figure 52 on the left shows the wall during the installation. To fix the wall-heating system, 15 mm thick oriented strand boards (OSB) were screwed onto the polyurethane strips in front of the VIP. Heating pipes were fixed to these panels and plastered over with loam. Figure 52 on the right shows the wall when the VIP and polyurethane strips had been installed.



Figure 52: Left: Installation of the VIP with dispersion based mortar onto the polystyrene boards. The horizontal strips of polyurethane can be seen as well as the vertical strips of dispersion based mortar.

Right: Photo of the wall before the OSB were mounted over the VIP

4.11.2 Building physics and engineering

The strips of polyurethane cause thermal bridges, but fix the heating system. To prevent moisture from inside the room getting into the wall, the gaps between the VIP were sealed with tape. In addition, 1 cm thick boards of polystyrene were fixed on the natural stones. The gaps between the VIP and the polyurethane strips are only 1-2 mm because the foil edges of the VIP were folded in a special manner.

4.11.3 Planning and execution procedure

The construction was developed by the architect Werner Haase, Karlstadt, Germany. He also supervised the installation and managed the work. The VIP measured $0.5 \times 1.0 \times 0.02 \text{ m}^3$. Figure 52 shows the wall before the loam was applied over the heating pipes.



4.12 Jamb-crossbar construction

Extension of the Hospital in Erlenbach/Germany

Construction, Insulating Glass and Panels:
GLASKEIL GmbH & Co. KG, Würzburg, Germany

VIP-products:
WACKER CHEMIE GmbH, Kempten & va-Q-tec AG, Würzburg, both Germany

Date of realization:
September 2001

Funding:
Bavarian State Ministry for Economics, Infrastructure, Transport and Technology



Figure 53: Outside view of the façade

A jamb-crossbar construction with vacuum insulation panels is being tested in the newly-built extension of Erlenbach Hospital. The aim was to install elements with the same thickness as insulated window panes. A typical jamb-crossbar construction made of aluminium was installed. The total thickness of the façade element was limited to 32 mm. Vacuum-insulated elements were installed instead of 70 mm thick conventional insulation. Figure 53 shows the outside view of the façade.

4.12.1 Material and construction

The theoretical improvement in the U-value should be from $0.57 \text{ W}/(\text{m}^2\cdot\text{K})$ to $0.22 \text{ W}/(\text{m}^2\cdot\text{K})$ with a 18 mm thick VIP. Because of the thermal bridges at the edge of the element, the real U-value for this element size (about 1 m^2 with two VIP measuring $0.5 \times 1.0 \text{ m}^2$) is $0.6 \text{ W}/(\text{m}^2\cdot\text{K})$. The elements were installed in a conventional jamb-crossbar system made of



aluminium, which causes great thermal bridges. The U-value of the façade therefore depends on the size of the elements. The material of the spacer was varied between stainless steel and Purenit (hard polyurethane foam).

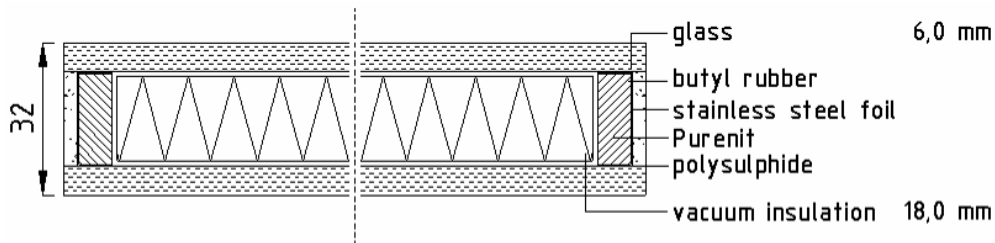

Figure 54: Cross-section of a façade element. In some elements, one pane of glass was exchanged for 3 mm thick sheet aluminium and the other pane of glass was 8 mm thick.

4.12.2 Building physics and engineering

The different spacers cause different thermal bridges (see Figure 55). The negative influence of stainless steel spacers can be seen clearly on the left hand side. If the vacuum fails, the U value of the element would deteriorate from 0.6 to 1.1 W/(m²·K). The elements can be replaced like a window pane. The insulation efficiency can be tested by taking infra-red images.

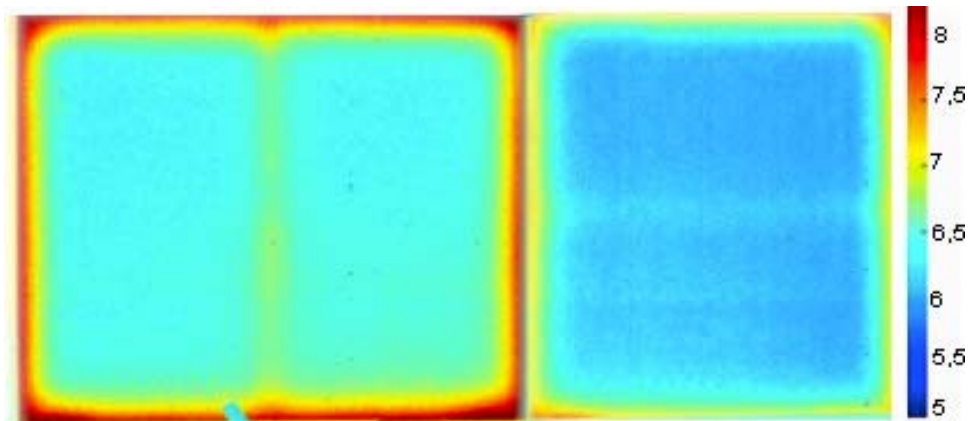

Figure 55: Infra-red image of two elements. On the left hand side the spacer is made of stainless steel and on the right hand side the spacer is made of Purenit.

4.12.3 Planning and execution procedure

GLASKEIL GmbH & Co. KG planned the construction and produced and installed the elements. The Bavarian Center for Applied Energy Research, ZAE Bayern, supported the project by calculating vapour and heat transport in the wall. Moreover, infra-red images are being taken each year to monitor the homogeneity of the insulation. Figure 56 shows the construction being installed.



Figure 56: Photograph of the vacuum-insulated façade elements being installed

4.12.4 Costs, benefits, risks

This project showed that vacuum insulation panels can be excellently integrated into jamb-crossbar constructions. It is advantageous that the elements can be manufactured in the factory so they can be installed in the same manner as window panes at the building site. The VIP are protected from damage. Special mounting systems do not have to be developed. GLASKEIL GmbH & CO. KG will continue to offer building elements in their product range. The envelope foil was folded differently by the two VIP manufacturers. The WACKER CERAMICS folds caused gaps between the VIP and spacers and between VIP. These can be recognized from inside the building when the sun shines through the gaps. The elements had to be removed and the gaps sealed with tape. Figure 57 shows the difference between the gaps.

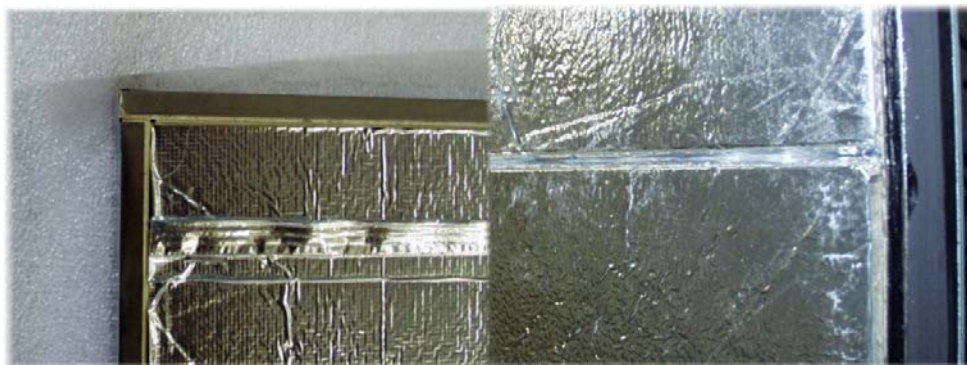

*Figure 57: Gaps and edges of VIP in the elements
left: va-Q-tec AG VIP
right: WACKER CHEMIE VIP*



4.13 Integrated façade element with radiator

Test façade ZAE Bayern in Wuerzburg/Germany

Construction:

Metallbau Ralf Boetker GmbH, Stuhr, Germany

VIP-product:

Bavarian Center for Applied Energy Research, ZAE Bayern, Würzburg, Germany

Date of realization:

February 2000

Funding:

Deutsche Bundesstiftung Umwelt, DBU

A façade element with integrated radiator was installed into the test façade (jamb-crossbar construction) of the Bavarian Center for Applied Energy Research (ZAE Bayern) in Würzburg (Germany). This slim façade system is insulated with vacuum insulation panels. Figure 58 shows the integrated façade system from inside the room. In comparison to the conventional radiator with vertical pipes on the left hand side of the picture, the radiator within the metal casing in front of the slim façade element is hardly noticeable.



Figure 58: View of the integrated façade system from inside the room

4.13.1 Material and construction

The façade element behind the encased radiator represented here is only 24 mm thick. Two 50 x 100 cm² VIP with a thickness of 20 mm are sandwiched between two aluminium plates (3 mm and 1 mm thick) and fixed inside a frame. Although the U-value in the centre is only 0.24 W/(m²·K), the U-value of the element as a whole is 1 W/(m²·K). A cross-section of the element can be seen in Figure 59.

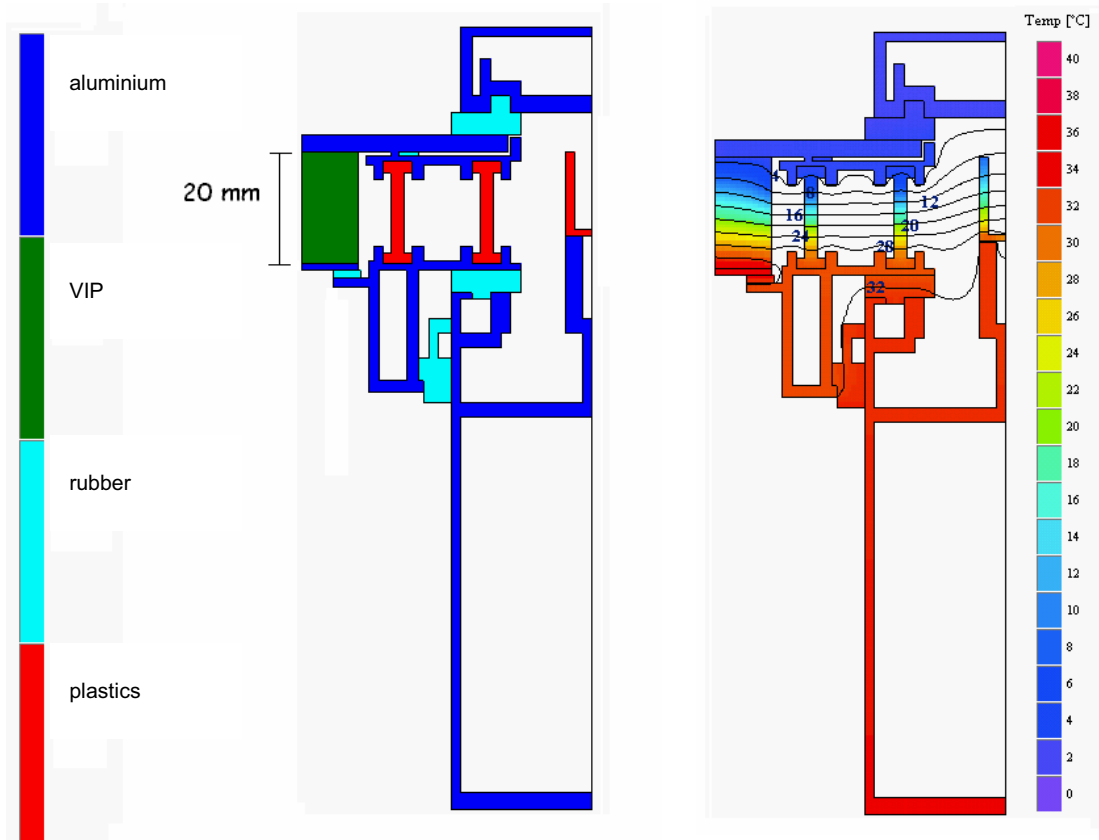

Figure 59: Left: Cross-section of the façade element without the radiator. The jamb-crossbar construction can be seen on the right hand side. The VIP is cut off on the left side. Right: A Finite-Element-Program was used to simulate the temperatures shown in this cross-section. The temperatures are colour-coded and the isotherms drawn in.

4.13.2 Planning and execution procedure

The construction was developed by Metallbau Boetker GmbH and the system is patented. ZAE Bayern simulated the construction to locate thermal bridges and to calculate the overall U-value. ZAE Bayern also produced the VIP and installed the façade element.

4.13.3 Costs, benefits, risks

This is a slim façade element that insulates very well. The system as a whole (with the integrated radiator) is a space-saving solution for slim façades. The VIP are protected within the system against damage during transport and installation at the building site. The radiator is simple to connect. A significant problem is the thermal bridge caused by the frame and the profile. This thermal bridge must be reduced by using materials with less thermal conductivity and by filling holes with insulating materials. Faulty vacuum insulation panels can be detected using infra-red imaging. The façade element can be removed, the VIP replaced and the element reinstalled.



4.14 Insulated prefabricated concrete elements Office building with an apartment in Ravensburg/Germany

Construction:

Albert Hangleiter GmbH & Co. KG, Ravensburg, Germany

Contact:

Dipl.-Ing (TU) M. Hangleiter, Phone: ++49 751 36160-0

VIP-product:

WACKER CHEMIE GmbH, Kempten, Germany

Location:

Ravensburg, Germany

Date of realization:

May 2004

Funding:

German Federal Ministry for Economy and Labour, Funding Ref.: 0327321 C

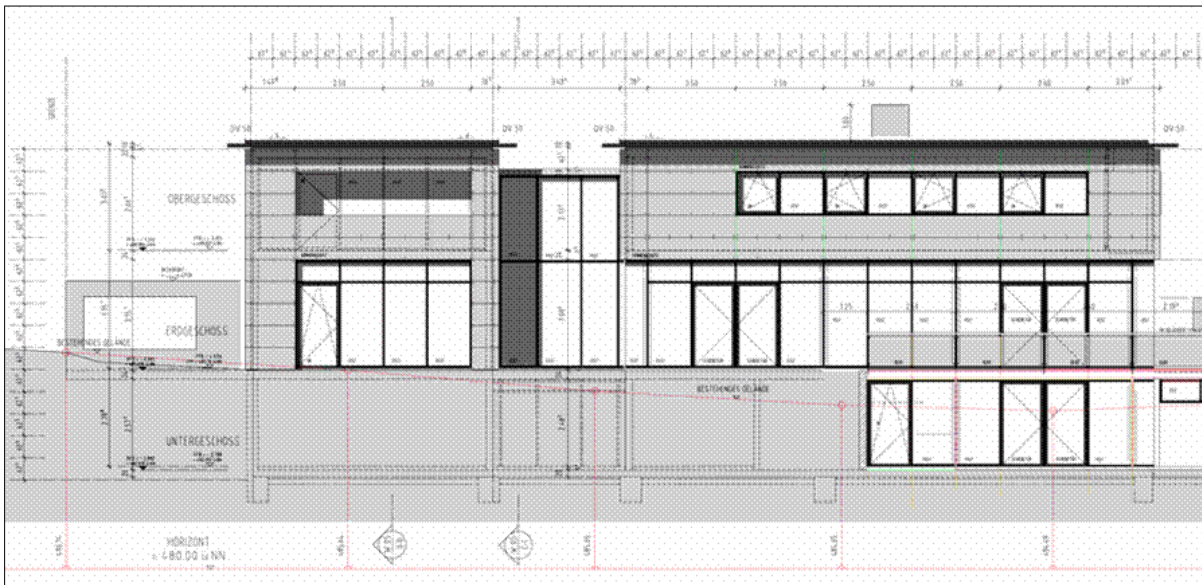

Figure 60: Plan of the house with prefabricated concrete elements.
The horizontal and vertical framework necessary for mounting the VIP is easily recognizable.

In this project, VIP are laid onto fresh cement and held in place with a few anchors to produce prefabricated concrete elements. Due to the special design of the elements, VIP can be replaced at any time, if necessary. The elements provide a very slim construction with few thermal bridges (U -value $0.15 \text{ W}/(\text{m}^2\cdot\text{K})$) and due to the fact that they are prefabricated, installation is facilitated and a high degree of quality assured. On failure of the vacuum the U -value of the wall construction would deteriorate from 0.15 to $0.4 \text{ W}/(\text{m}^2\cdot\text{K})$.

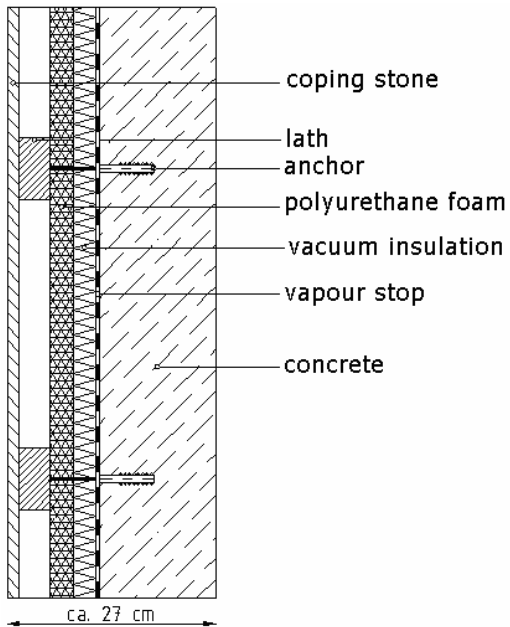

Figure 61: Left: Intended design for the prefabricated wall elements. An average U-value of $0.15 \text{ W}/(\text{m}^2\cdot\text{K})$ is achieved with a total thickness of only 27 cm. Right: Photo of a prefabricated wall element



4.15 Façade insulation

Passive house in Bersenbrueck/Germany

Construction VIP-System:

Sto AG, Germany

Contact:

Sto AG, Markus Zwerger, m.zwerger@stoeu.com

VIP-product:

Sto AG / Porextherm Dämmstoffe GmbH

Location:

Passivhaus Bersenbrück, Germany

Date of realization:

2002/2003

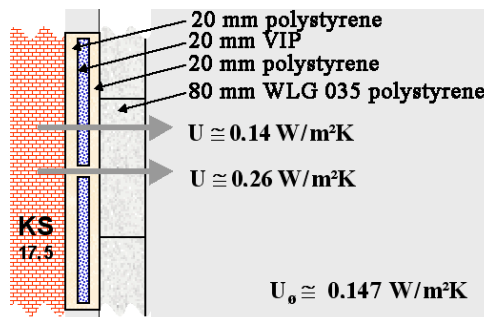

Figure 62: Left: View of the house from the south-west; several polystyrene-encased VIP are already mounted. Thermographic image taken after the second layer of insulation was mounted.

Right: Cross-section of the façade insulation. The given U-values correspond to (top to bottom): the centre of the panels, the joints and the average for the total area.

The passive house in Bersenbrück was completely insulated with vacuum insulation panels set in polystyrene. The VIP are 20 mm thick and encased by 20 mm thick WLG 035 polystyrene on each side. A second, 80 mm thick layer of insulation was also mounted to minimize any joint porosity or thermal bridge effects. The target specification of $0.15 \text{ W}/(\text{m}^2\cdot\text{K})$ was therefore achieved with a theoretical average U-value of $0.147 \text{ W}/(\text{m}^2\cdot\text{K})$. Thermographic images taken of the building before and after the second layer of insulation was mounted clearly show that the initial thermal bridges in the joint areas can be reduced.



4.16 Façade insulation with polystyrene-lined VIP Terraced house in Trier/Germany

Construction VIP-System:
Sto AG, Germany

Contact:
Sto AG, Markus Zwerger, m.zwerger@stoeu.com

VIP-product:
va-Q-tec AG, Wuerzburg, Germany

Location:
House exhibition, Petrisberg, Trier, Germany

Date of realization:
2004

Funding:
German Federal Ministry for Economy and Labour, Funding Ref.: 0327321 J

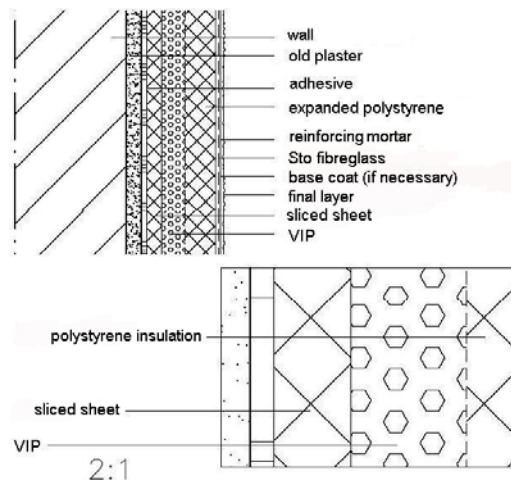

Figure 63: Left: View of the passive house with lined VIP. The black façade has conventional, 30 cm thick insulation to demonstrate the difference in thickness compared to the red façade insulated with VIP.

Lined VIP being mounted onto the façade
Right: Cross-section of the wall

Twelve terraced houses designed with innovative technology have been built for a house exhibition within the framework of the Trier Garden Show 2004. The passive houses designed by the architects Lamberty, Schmitz & Hoffmann utilize polystyrene-lined VIP from Sto AG. These 20 mm thick VIP are lined at the front and back with polystyrene. The panels fit flush and therefore create only a minimum of thermal bridges.



4.17 Façade insulation

Refurbishment of an apartment and office block in Munich/Germany

Construction:

energie-tib, Bindel, Jenne, Krauter & Becker

Contact:

info@energie-tib.de

VIP-product:

va-Q-tec AG, Würzburg, Germany

Location:

Ultra-low-energy apartment and office block, in Munich, Seitzstr. 23

Date of realization:

March - August 2004



Figure 64: Left: The building after renovation.

Right: Mounting the polyurethane foam panels onto the ceiling.

Monitoring the gas pressure within the VIP with the portable 'va-Q-check' device.

The east, south and west façades were equipped with approx. 850 m² of vacuum insulation. The vacuum insulation panels were fixed to the concrete walls with adhesive. The VIP were installed between vertical laths of recycled polyurethane fixed with wall plugs. The polyurethane foam panels onto which the plaster was applied are securely attached to these laths.



4.18 Floor insulation

Renovation of the Allgäu Energy and Environment Centre Kempten/Germany

Construction:

BaumitBayosan GmbH & Co. KG (Bad Hindelang) and Prill & Schurr Architects

Contact:

Rudolf Schäfer, rudolf.schaefer@baumitbayosan.com

VIP-product:

WACKER CHEMIE GmbH, Kempten, Germany

Location:

Allgäu Energy and Environment Centre (eza! house), Kempten, Germany

Date of realization:

2001

Funding:

Bavarian State Ministry of Economics, Infrastructure, Transport and Technology



Figure 65: View of the eza! house. (foto: may.schurr.architekten, Bad Wörishofen)

Outside floor/ceiling renovation with vacuum insulation

The cellar ceiling was insulated from the outside (part of the cellar is beneath the outside entrance area) during a renovation. 3 cm thick polystyrene-encased VIP were installed underneath the paving, therefore insulating the ceiling below. The encased elements measured $50 \times 50 \times 3 \text{ cm}^3$, whereby the VIP inside measured $48 \times 48 \times 1 \text{ cm}^3$. The advantage of the encased VIP is that they are easy to handle, but when fully encased, the VIP can no longer be visually checked for flaws. The polystyrene edging also increases the U-value - $0.28 \text{ W}/(\text{m}^2\cdot\text{K})$ in the centre of the element and $0.35 \text{ W}/(\text{m}^2\cdot\text{K})$ for the total area.

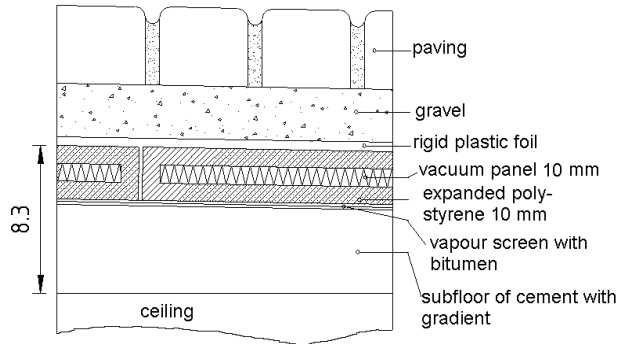

Figure 66: Left: Installing the polystyrene-encased VIP. The border between the floor and the house was filled with pieces of polystyrene. (foto: may.schurr.architekten, Bad Wörishofen)
Right: Insulation design

On failure of the vacuum the U-value would deteriorate from 0.35 to 0.65 W/(m²·K).

Inside floor renovation with vacuum insulation

The cellar was to be used as a classroom subsequent to renovation. The height of insulation was limited. To achieve acceptable floor insulation values the flooring inside was realized with a sandwich design. The 2 cm thick VIP were laid between softboard and polystyrene. A layer of OSB was installed above. This floor set-up achieves a U-value of 0.17 W/(m²·K).

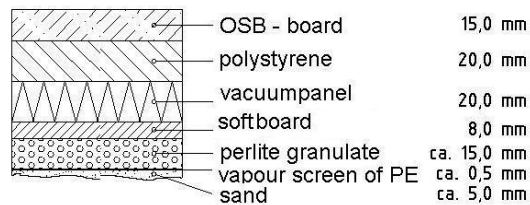

Figure 67: Left: Photo taken during renovation. The OSB can be seen in the foreground, the VIP in the centre and the softboard in the background. (foto: may.schurr.architekten, Bad Wörishofen)
Right: Cross-section of the floor set-up



4.19 Floor insulation

Renovation of the historic court house in Schaffhausen/Switzerland

Construction:

Mion-AG, Neuhausen am Rheinfall, Architect: Rolf Lüscher, Schaffhausen, Switzerland

Contact:

Gregor Erbenich, gregor.erbenich@porextherm.com or Guido Bründler, guido.bruendler@zzwancor.ch

VIP-product:

Porextherm Dämmstoffe GmbH - ZZWancor, Switzerland

Location:

Historic court house in Schaffhausen, Switzerland

Date of realization:

August 2002



Vacupor: Design and U-values

Flooring underlay

U-value: 0.30 W/m²K with 15 mm Vacupor

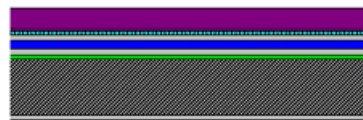

Design (from inside to out)

- 40 mm flooring underlay (Anhydrite or Maxite)*
 - polyethylene film *
 - 5 mm Ethafoam SD 5 (extruded PE foam)
 - 15 mm Vacucomp
 - 5 mm Ethafoam SD 5 (extruded PE foam)
 - 3 mm vapour barrier *
 - 200 mm reinforced concrete
 - 10 mm plaster * to be provided by customer
- Total thickness over concrete with
15 mm Vacucomp = 70 mm

Figure 68: Left: Entrance area of the historic court house in Schaffhausen / Switzerland. The doors inside the building originate from the 17th century as well and had to be retained.

Middle: Mounting the vacuum panels according to an assembly plan. VIP with irregular, slanted sides had to be specially supplied for the edges of the room. All the VIP were numbered according to the plan.

Right: Typical floor construction with Vacupor® - Vacuum Insulation Panels

The task was to transform an unheated room in an old court house, built in the 17th century, into a heated and therefore usable space.

Two problems had to be solved:

1. This part of the building had a cellar underneath
2. Space and height were limited due to the fact that it was not possible to install new doors. The old historic doors as well as the doorframes were too low to install thick floor insulation. To achieve acceptable floor insulation values against the cold coming from the cellar without adding too much height, the only solution was to use Vacucomp® (ZZWancor's trademark) vacuum insulation panels. This insulation problem was solved by using a three layer system of 5 mm Dow 'Ethafom SD', 10 mm VIP and again 5 mm Dow 'Ethafom SD' without ruining the historic character of the building.



4.20 Renovation with insulation under underfloor heating Renovation of a gymnastics hall in Gemünden/Germany

Construction:

Rosel engineering, Wuerzburg, Germany

Contact:

ZAE Bayern, Hubert Schwab, Schwab.Hubert@zae.uni-wuerzburg.de

VIP-product:

WACKER CHEMIE GmbH, Kempten, Germany

Location:

Sports hall Gemünden, Germany

Date of realization:

July 2001

Funding:

Bavarian State Ministry of Economics, Infrastructure, Transport and Technology

The floor of the sports hall in Gemünden am Main (Germany) was worn down and the heating system had to be renewed. There were two alternatives: either to install a new air-conditioned heating system or to install underfloor heating. It was decided to install underfloor heating and a ventilation system with heat recovery. The ventilation is controlled by air quality sensors and limited to 300 m³/h during sport activities. The height of the floor was limited by the boxes for the sports equipment and could not be increased, because it would have been too expensive. One part (45 m²) of the area was insulated with VIP.

4.20.1 Material and construction

Conventional insulation was integrated in another part of the floor. The conventional insulation (4 cm polyurethane and 3 cm polystyrene boards) is of the same thickness as the vacuum insulation (2 cm polyurethane, 2 cm VIP and 3 cm polystyrene boards), yet the U-value of the conventionally insulated area is 0.43 W/(m²·K) and that of the VIP-insulated area is 0.15 W/(m²·K).

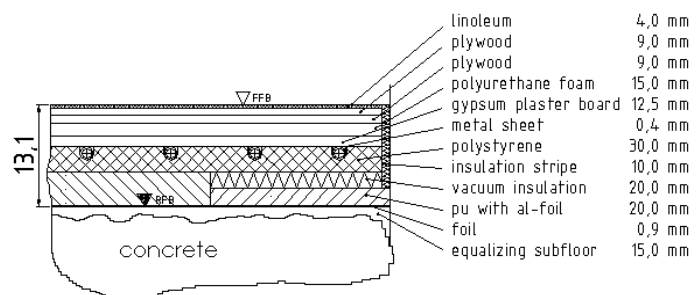

Figure 69: Left: Photograph of the floor during the installation. The shiny VIP are put on the matt aluminium layer of the polyurethane boards. The VIP were connected with tape. White polystyrene plates with grooves for the heating pipes are mounted on top of the VIP. Right: Cross-section of the floor insulated with polystyrene as well as with VIP



Figure 69 on the right shows the cross-section of the floor for the part with vacuum panels as well as with conventional insulation. After the old floor had been removed it was necessary to put in a new subfloor. The gaps between the VIP were sealed with tape. Another layer of white polystyrene panels with grooves for the heating pipes were mounted on top of the VIP (Figure 69 on the left).

4.20.2 Building physics and engineering

Installing VIP in floors is very easy because they do not have to be fitted into a system. The only drawback is that the VIP have to be treated with caution: as they must not be trodden on directly (= damage) the polystyrene panels must be mounted on top of the VIP straight away (as can be seen above). During installation, care has to be taken to avoid bringing foreign bodies (e.g. sand, crumbs, etc.) into contact with the VIP (= risk of damage to VIP).

The vacuum creates a pressure of 100 kN/m² on the VIP core. DIN 1055 requires a load of 1.5 to 5 kN/m². This means an increase in pressure from 1.5 to 5 % which can easily be carried by the filling material. Normal weights are no problem for VIP.

4.20.3 Planning and execution procedure

The Ingenieurbüro Rosel (Engineers) planned and managed the renovation. The vacuum insulation panels were installed by the Bavarian Center for Applied Energy Research, ZAE Bayern. Care was taken to ensure a reasonably clean floor to prevent damage to the vacuum inside the VIP. The VIP themselves were also handled very carefully. The VIP measured 0.5 x 1.0 m².

Infra-red imaging could not be carried out on the VIP as the metal sheet used to distribute the heat provides for the same temperature over the entire floor surface.

4.20.4 Costs, benefits, risks

The application of VIP in floors is especially interesting for renovation. The height of the insulation is normally limited and the necessary U-values can not be reached with conventional insulation materials. If the floor borders on the earth, the U-value must be smaller than 0.5 W/(m²·K) (according to EnEV, German energy saving regulation). When mounted on floors, VIP do not need to be fitted into any kind of railing system (which would cause thermal bridges). The VIP can be installed quickly and with practically no thermal bridges, if the work is done carefully. It would be helpful to develop a procedure to test the quality of the mounted VIP.



5 Use of VIP – recommendations

On the basis of numerous contacts with firms, comprehensive publications from practice and research, the following recommendations for the installation of VIP can be made.

In the following, a distinction will be made between

- Recommendations valid for the entire construction domain
- Recommendations applying specifically to the use of VIP delivered to the construction site in the 'raw' condition and then installed or mounted there
- Recommendations for prefabricated component systems, in which VIP are built in and more or less protected on the construction site.

Apart from the recommendations in each case, typical applications will be presented and discussed critically.

5.1 Overall construction domain

5.1.1 Information / Consulting

VIP is more than a new material – it must rather be regarded as a system, one of considerable complexity and sensitivity. It is therefore important that all concerned be informed, advised as early as possible and be supported by a specialist during the entire planning and installation process (preferably by the VIP supplier). In whatever way VIP are used in the construction branch, those responsible should make sure that during the planning and building process, no one handles VIP without having sufficient knowledge of its properties. Postal parcels with sensitive contents are marked with a 'Handle with care' label because they pass through many hands.



Figure 70: Draft sketch for an adhesive warning label to mark VIP panels and building components containing VIP

VIP used in construction, which also pass through many hands, should also be labelled adequately. VIP should, as a rule, fulfil their function in buildings over decades. Wherever they are not installed absolutely safe from damage, tenants, owners and renovation workers



should also be warned with a label of the sensitive contents of building components. We thus recommend VIP manufacturers and suppliers to develop a warning label. Figure 70 illustrates this thought in the sense of a suggestion.

5.1.2 Edge effect

VIP are remarkable for their very good thermal resistance in the undisturbed region. However, because of the good thermal conductivity of the edges of the panel (the aluminium part of the laminate), the λ -value of the overall panel is poorer. Depending on the type of VIP, panel size and shape, this effect will vary and may even cancel out the advantages of the material. A method of quantifying the mean U-value of constructions with VIP layers is given in chapter 3.3. The following advice can be given as a guideline for minimizing the edge effect:

- Select panels that are as square and large as possible (min. 0.5 x 0.5 m²)
- If the envelope of the panel is made of aluminium foil – nowadays mostly multi-layer films are used – lay the panels in a double layer, overlapping by at least 5 cm (which, however, is expensive).

5.1.3 Detail processing

VIP must be well protected from mechanical damage. This applies equally to functional loading (e.g. from the floor), inadvertent loading (e.g. dilatation) and subsequent manipulations (e.g. nailing).

Furthermore, one must pay special attention to various joint details, since protecting components (e.g. angle brackets for window attachment, guide rails, frames) may damage the VIP.

5.1.4 Water vapour diffusion

VIP are vapour-tight insulation systems, which has to be taken into account in planning the order and thickness of the layers. Furthermore, special attention must be given to the joints between the panels. The joints and edges are usually sealed with a special adhesive aluminium tape, which assures tightness but is relatively brittle.

5.1.5 Replaceability of the VIP

The tests and experience available to date suggest that with proper handling, the vacuum in VIP made with the present technology will remain intact past the expected four to five decades of service. But the possibility of individual panels or entire areas failing should nevertheless be included as a risk in the planning and execution. A strategy would be desirable that would aim at being able to replace the VIP in case of failure. This implies two things that in our experience to date are not usually paid attention to:

- Means should be sought in the design of the VIP system to facilitate replacement as much as practicable, if the particular application is expected to lead to a high failure rate.
- Installation of the VIP in such a way that inspection of their correct functioning can be made, particularly with infrared thermography. As a rule this is impossible if on both



sides, either well conducting, massive covers (e.g. concrete) or back-ventilated constructions are employed (provided that the latter cannot be removed relatively simply for checking the VIP).

As a rule, one has limited oneself up to now to mitigating the effects of failure, so that a deterioration in the U-value can be accepted and it is assured that on loss of vacuum, there is no risk of loss of comfort or of condensation.

5.1.6 Handling of VIP

The workers who deal with VIP must be trained in handling these materials. Adequate tools and aids must also be made available to them. On the basis of our observations, two main aids would be sensible for working with VIP on site, and these should be supplied by the supplier together with the VIP:

- Felt overshoes or the like
- Felt-covered boards with handles of the like as platforms and load-spreaders, so that the workers can kneel on freshly laid VIP without causing dents and risking damage.

5.2 VIP on the construction site

5.2.1 General recommendations

Parts lists and laying plans

With VIP no tolerances are absorbed and the panels cannot be cut to size on site. For this reason, exact parts lists and laying plans must be drawn up at an early date (in co-operation with the VIP supplier). Suitable insulation materials must be specified and made ready for taking up tolerances or adapting to edge joints.

Delivery and storage

It must be clarified how (package, weight, protection, accessibility) and when the VIP will be delivered, in order to assure permanent protection to the material. Large packages with VIP tend to be extremely heavy (owing to the relatively high bulk density of the fumed silica core) and are a hindrance to careful handling.

Cleaning

The working area must be thoroughly cleaned and sharp-edge irregularities and projections removed.

Assembly of the VIP (pay attention to protection!)

Lay a protective mat, lay the VIP, carefully lay a second protective mat at once, because in work breaks (midday, night) there is a risk that the VIP will be walked on (the materials attract curious spectators from the building crew). Objects may fall on the VIP. Even if the work is carried out in socks, sharp objects may stick to the socks.



Moisture

On installation, one should pay attention to dry materials and dry weather. Already small amounts of water (rain drops), because of sealing on all sides in some constructions, can lead to a permanently increased vapour pressure in the entire construction, which in the worst case can even be detrimental to the insulation properties of the VIP.

5.2.2 Outer walls with interior insulation

The sensitive points in internally insulated buildings from the standpoint of building physics have been known for a long time and adequately discussed: heat bridges at wall and ceiling joints can hardly be avoided, heat losses and increased liability to condensation are the results. Nevertheless, this type of insulation is often executed for a variety of reasons. Architectural but also engineering advantages, primarily during renovation, are apparently more important than the disadvantages mentioned. With regard to the large number of historic buildings, it is obvious that interior insulation will be an increasingly important concept in energetic renovation. With this type of building project, reduction of insulation thickness is of special importance, since each centimetre of thickness saved contributes to the conservation of valuable useful space.

Here we select a typical case (Figure 71) from a variety of possible given constructive situations. Examples of the type shown here cannot be applied to other situations without previous careful clarification of the specific local parameters.

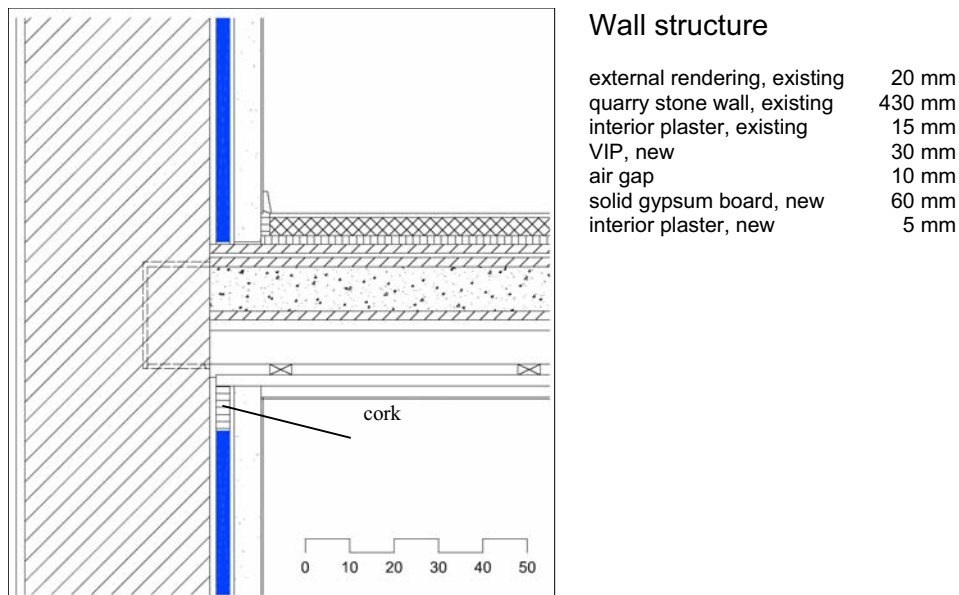

Figure 71: Section through the support of the ceiling

Engineering

Within the scope of renovation, when drawing up exact parts lists and laying plans, one must take into account the corresponding tolerance ranges. Installation of conventional insulations



in these tolerance ranges leads not only to thermal bridges, but also to additional weakening of the insulation perimeter. Furthermore, it must be assured that not too many small sized VIP are installed since the larger edge losses from the individual panels would further lower the insulation effect. Finally, with interior insulation, special precautions must be taken to protect the VIP from user influences (damage by screws, nails, electrical installations etc.).

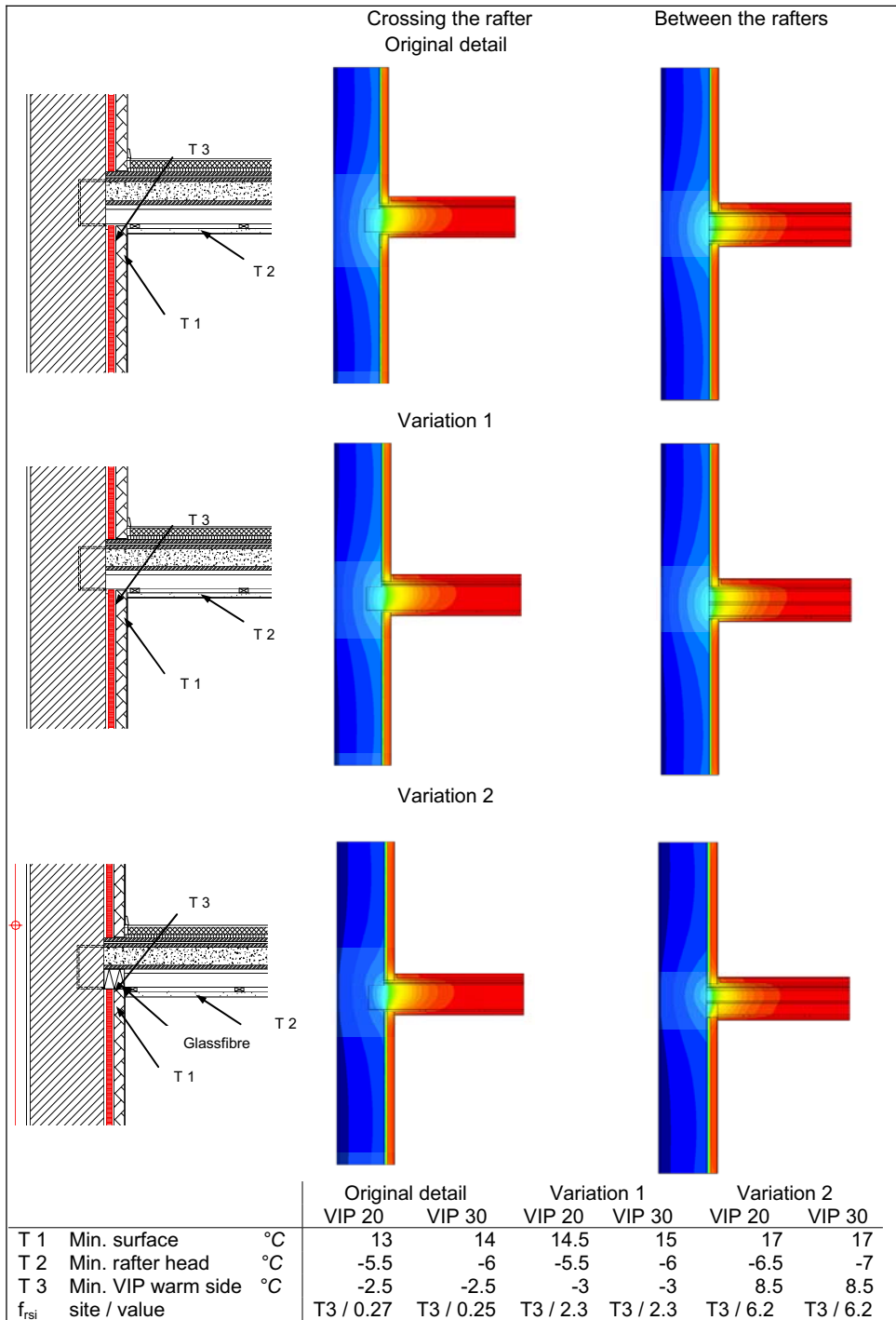

Figure 72: Three-dimensional computational heatflow analysis of the support of the ceiling



Moisture

With all interior insulation, the possibilities of condensation of room humidity must be considered. In this, all **four condensation risks** must be individually examined and avoided. The risk of **surface condensation on the joints** in the interior insulation between ceilings and walls will tend to be increased with VIP. As shown in Figure 72, the temperature rises only minimally in the critical region (Figure 72, T1) if the filling elements between VIP layer and ceiling or wall joint, anyway necessary, are executed in normal insulation. Depending on the situation, the construction thermally approximates the uninsulated state by the selection of filling materials with relatively poor insulating properties in the region of the joint. The choice of moisture buffering materials in the region of the joint (Figure 72, original detail, e.g. cork) helps to prevent fungal attack. **Condensate from rear ventilation** must be avoided, which is relatively easy: the VIP must be applied tightly with as few cavities as possible to the outside wall and gaps and joints carefully taped on the room side. The latter measure is also a reliable way of avoiding **condensate from vapour diffusion** in the wall construction. VIP are inherently vapour tight (in the sense of processes relevant to building physics), so that primarily the gaps and joints must be taped. Adjacent hollow ceilings, where usually no vapour barrier can be installed, should where possible at least be stuffed or blown with fibre insulation (Figure 72, variation 2) to make sure that no convective moisture transport to the cold surfaces can occur. A danger is **air leak condensate**, as can occur in the case of gaps and cracks that are continuous from inside to outside. These must be avoided at all costs. Air leak condensation, e.g. in the region of wooden beam ends, can cause rapid deposition of large quantities of condensate, which quickly leads to rotting in this important zone. With careful prior clarification, however, one can reliably determine whether such continuous openings exist and whether and how they can be eliminated. The issue of air leak condensation arise with all types of insulation, not just with VIP.

5.2.3 Terrace insulation

The use of VIP for the thermal insulation of terraces is interesting both for new buildings and renovation. At present, it is the most frequent application of VIP in Switzerland. Compared to conventional insulation materials, the lower installed height of VIP enables a level transition from inside to outside without provision of a step in the reinforced concrete slab. This raises the comfort and even makes the use of a wheelchair possible.

Figure 73 shows the joint of a VIP insulated terrace to balcony glazing with wood framing.

Engineering

On the basis of a survey on site, an exact laying plan for the VIP must be prepared. If necessary, the use of conventional insulation at the edges can be minimized with individually made-to-fit pieces. Otherwise, a deterioration in the U value must be accepted.

During laying on site, the VIP can very easily be damaged by falling objects and incautious walking. One must therefore make sure that the VIP is covered by a protective layer as soon as possible to avoid such damage.

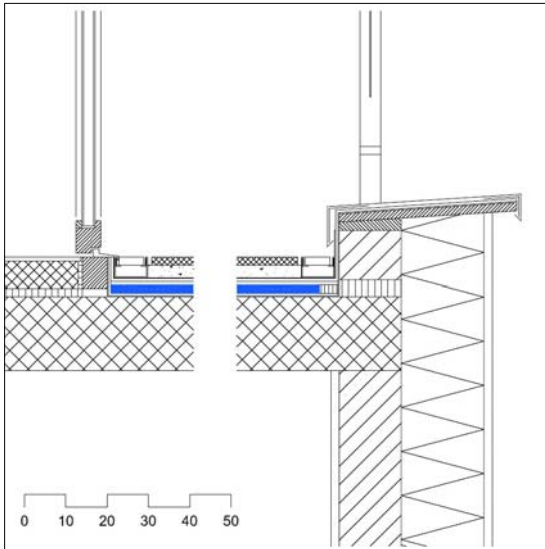

Floor structure

garden tiles	20 mm
flint (draining)	30 mm
protection mat	
bitumen sealing	
rubber meal mat	
VIP	20 mm
PE foam mat	
vapour barrier	
concrete ceiling	200 mm

Figure 73: Section through the terrace construction

Moisture

Detailed investigations in building physics were executed on this construction at the EMPA [4]. Figure 74 shows the three-dimensional computational heatflow analysis of the detail. Certain layers in the construction (concrete slab, VIP and seals) exhibit high vapour tightness. With proper execution, condensation can be excluded in the construction. In addition the VIP, through embedding in conventional insulation and by sealing, are well protected against mechanical damage, large temperature excursions and moisture.

On installation, one should pay attention to dry materials and dry weather. Already small amounts of water (rain drops), because of sealing on all sides, can lead to a permanently increased vapour pressure in the entire construction, which in the worst case can even be detrimental to the insulation properties of the VIP.

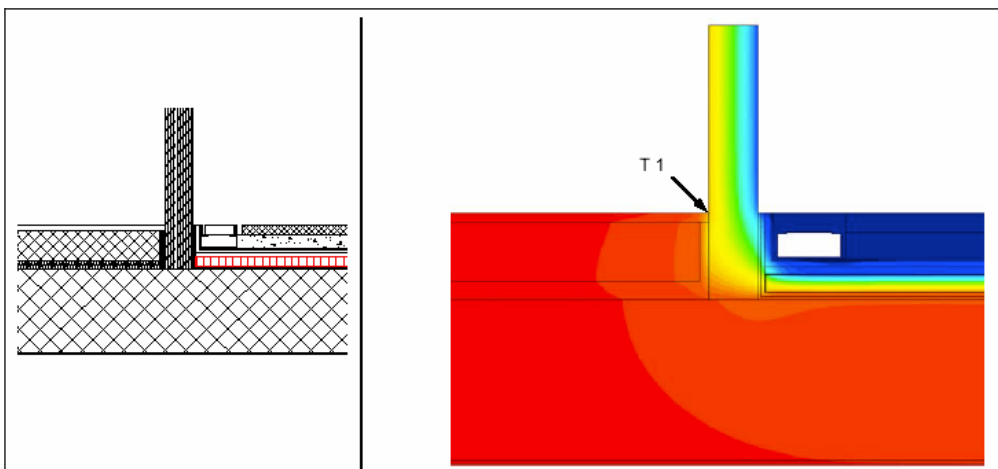

Figure 74: Vertical section through the terrace construction and three-dimensional computational heatflow analysis. The calculated temperature T1 is 14 °C.



5.3 VIP in Prefabricated Components

5.3.1 General recommendations

Application of vacuum insulation panels in buildings puts requirements on the panel that are often heavier than the requirements for traditional VIP applications, like refrigerators and mobile boxes. This is no different for on-site vacuum insulation panel application or prefabrication. However, on-site application of VIP brings some additional requirements regarding protection against damage during transportation, handling and application. Because these requirements are less important for prefabricated applications and because they are discussed elsewhere, they will not be addressed in this chapter.

Still, many other requirements exist. The most important of these can be summarized as follows:

- service life requirements
- thermal requirements
- structural requirements
- fire protection requirements
- acoustical requirements
- requirements regarding hygiene, health and environment
- application safety and fitness for use.

Service life requirements

The service life of a prefabricated component incorporating a vacuum insulation panel mainly depends on the thermal conductivity aging of the vacuum insulation panel inside. The properties of the other elements used for the component do not seriously change over time, if the component is designed properly. It is, however, important to specify the VIP operating conditions for which service life predictions can be performed. Three different conditions can be specified, the first of which is a condition for practical purposes: the average condition with respect to temperature and partial water vapour pressure under which the vacuum insulation panel has to operate in a practical application, based on measurements; the second of which is the Arrhenius average temperature and average water vapour pressure, again based on measurements in real applications; and the third of which is a more-or-less theoretical condition for testing and quality assurance: 23 °C and 50% relative humidity. Aging procedures to estimate the service life of a vacuum insulation panel by measuring the internal gas pressure increase under testing conditions different from the standard conditions are still under investigation.

Thermal requirements

The thermal requirements for the VIP component consist on the one hand of restrictions with regard to a maximum effective thermal transmittance to minimize thermal losses and on the other hand of a criterion for a minimum inside surface temperature to avoid surface condensation. For both requirements two construction properties are important: the center-of-panel,



or ideal, thermal transmittance and the linear specific thermal transmittance of the panel edge.

Structural requirements

For building panels the mechanical boundary restrictions have an important influence on the requirements that must be met by the vacuum insulation panel. For example, structural requirements on the vacuum insulation panel itself only apply to VIP used in sandwich components. In all other construction systems the vacuum insulation panel does not have to bear loads. The component in total (façade or door panel), however, does have to meet structural requirements, but the panel facings and edge spacer construction fulfil these.

Fire protection, acoustical and environmental requirements

The fire protection requirements for building panels mainly deal with fire prevention, fire spread and smoke reduction during fire. Because the exact requirements differ from country to country and state to state, they are not elaborated in this paper. This applies to the acoustical requirements and the requirements regarding hygiene, health and environment as well. For more information it is advised to contact a local specialist or to look at the local building codes and standards.

Interrelationships

The requirements presented in the preceding text all have a strong interrelationship among each other. These relationships are presented in Figure 75. One important relationship is between overall thermal performance of the panel and the structural system. On the one hand, thermal insulation requirements, in form of a maximum allowable U_{eff} , put some restrictions on the maximum heat losses due to cold bridging near the panel edges. On the other hand, however, structural requirements can put restrictions on the panel edge construction as well. Often both requirements counteract one another, but they still have to be met both. One way to solve this problem is by creating a sandwich component in which the facings are glued on top of the vacuum insulation panel. In this case only safety measures have to be taken at the edge to prevent complete panel failure after loss of vacuum in the core. Such a safety measure can be a simple non-metallic tape, which keeps both facings together in a failure situation. Another way to cope with the conflicting thermal and structural requirements is a panel construction with a mechanically and thermally optimized edge spacer. Such an edge spacer should be made of materials with a thermal conductivity as small as possible and practical and should occupy a projected surface area, seen from the front of the panel, as small as possible, at the same time having enough strength and giving the panel enough stiffness to be structurally safe.

A second important relationship is between the thermal requirements of the vacuum insulation panel and the service life. Thermal insulation requirements restrict the thermal conductivity of the ideal mid section of the vacuum insulation panel to some critical value. Depending on the qualities of the barrier envelope around the core material, this conductivity will increase less or more during a certain amount of time. This rate of pressure increase influences the service life of the vacuum insulation panel, and thus the service life of the entire building component. This service life, however, is influenced by maintenance and aesthetic



qualities of the component as well, which in turn are influenced by amongst others the structural properties of the building panel (deflections and flatness) and the environmental loads on the panel (wind, rain, moisture, UV-radiation). So, the structural qualities of the entire building panel do not only interact with the thermal insulation requirements, but in an indirect way with the service life as well.

This shows how important it is to make an integral design for building components with incorporated vacuum insulation panels. All aspects have to be taken into account from the early stages of the designing process until the demolition of the component.

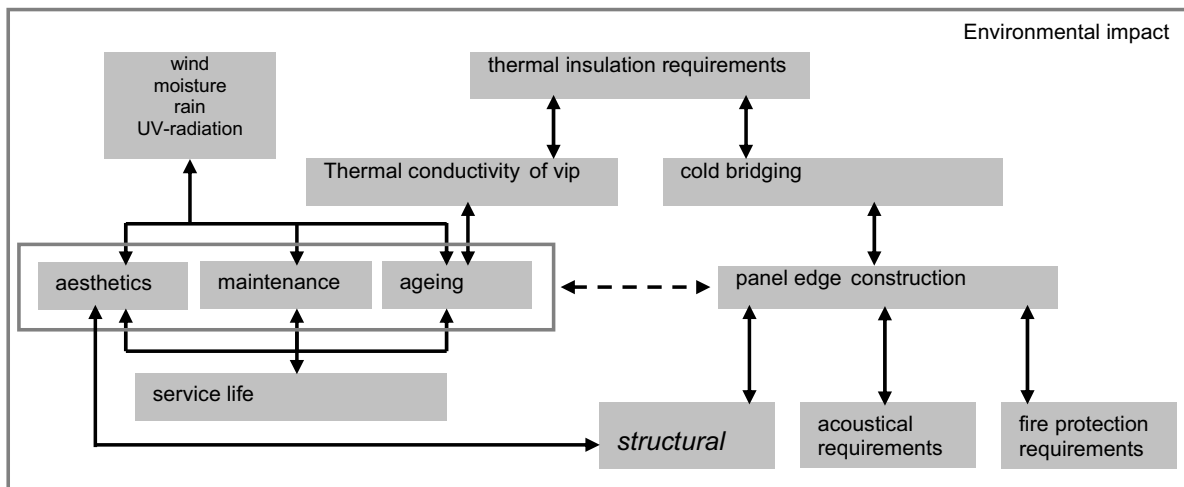

Figure 75: Relationships between different requirements for building panels with incorporated vacuum insulation panel.

Requirements on edge spacers

Mainly thermal and sometimes structural considerations have been mentioned until here. Other considerations, however, can play a significant role in designing an edge spacer for a façade panel. In this section some of the requirements imposed upon edge spacers are mentioned, for which a distinction into two different categories of requirements must be made: requirements specific for the application of vacuum insulation panels in façade panels and requirements applicable to all façade panels, regardless of the presence of a vacuum insulation panel.

Specific requirements

- protection of the vacuum insulated core against damage
- reduced thermal bridging at the edges by using materials with a low thermal conductivity and by reducing the width of the edge zone
- gas-tightness and air-tightness of edge
- mechanical connection of the outer to the inner facing in case of damage of the vacuum insulation panel
- accommodation of the seam, if one is present near the edges



General requirements

- mechanical connection of the outer to the inner facing to transmit forces under normal circumstances
- thermal stability
- dimensional stability
- moisture resistance and in some cases UV resistance
- taking account of differences in production dimensions
- manufacturability
- good cost-performance objective
- sustainability
- technical durability matched with required functional durability
- fire safety requirements
- acoustical requirements
- application safety and fitness for use

General recommendations for detailing prefabricated building panels

Whether a sandwich construction, i.e. the facings of the building panel adhered to the vacuum insulation panel, is chosen, or a construction with a load-transmitting edge spacer depends partly on manufacturing habits. It is, however, important that the type of edge spacer is adjusted to the type of panel construction. So, if a sandwich construction is designed, the edge spacer should not be part of the load transmitting system of the panel, unless the stiffness of the panel needs to be increased. In the case of a loss of vacuum, the edge spacer does, however, need to be able to temporarily keep the panel intact until it can be replaced by a new panel. The advantage of such a sandwich construction is that the edge spacer can be fairly simple, because it just needs to protect the VIP inside and act as a safety mechanism, resulting in a low thermal bridge effect. If, on the other hand, a construction with load-transmitting edge is required, the entire panel including edge spacer should be able to withstand all forces acting on the panel during manufacturing, transportation, installation, use and deconstruction with sufficient safety.

It is important that the vacuum insulation panel inside is protected against external forces or internal forces, e.g. restricted thermal expansion or sharp edges, to prevent damage of the panel. Damage of a vacuum insulation panel leads to loss of vacuum, and consequently to an increase in thermal conductivity. It must, however, be noted that a non-vacuum silica core still has a thermal conductivity of approximately $18 \text{ to } 20 \cdot 10^{-3} \text{ W/(m}\cdot\text{K)}$, which is lower than most conventional insulation materials. The thermal resistance on the other hand is quite low, because of the small thickness most vacuum insulation panels have. It is therefore necessary to work with sufficient caution and to handle the panels carefully during manufacturing of the building component.

Yet, if a vacuum insulation panel in a building component does get damaged, it should be able to be replaced easily, for which two strategies are possible. First, an entire building



component, that is VIP, facings and edge, can be replaced. Second, only the VIP can be replaced, leaving the component itself intact. This last option has consequences for the detailing of the edge spacer. The edge spacer in that case must be removed from the panel without damaging the panel and preferably the spacer itself. It is, however, easier to replace the entire panel.

Tolerances are of major concern, when designing and detailing building components. The standard concerns will not be addressed here. Special attention, however, must be given to the differences in production dimensions of vacuum insulation panels. The production tolerances of VIP are currently of the order of 3 to 6 mm in length and width. This means that in a building panel a gap between the nominal dimension of the VIP and the edge spacer, i.e. the maximum possible dimension of the VIP, of 1.5 to 3 mm is required on both sides of the panel (Figure 76), space required for the seam not included. This air gap, although small, does conduce to a higher thermal conductivity value for the panel as a whole. It is therefore important that production tolerances for vacuum insulation panels go down to 2 to 3 mm, notwithstanding the panel dimensions.

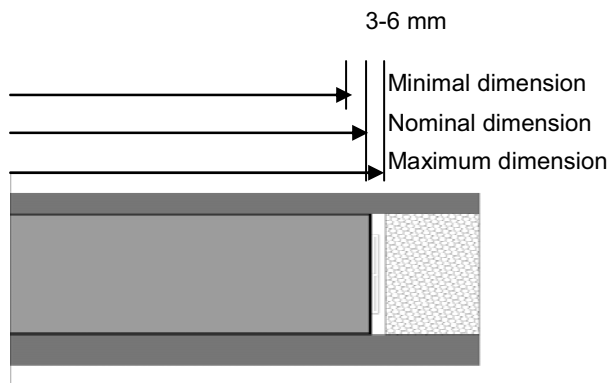
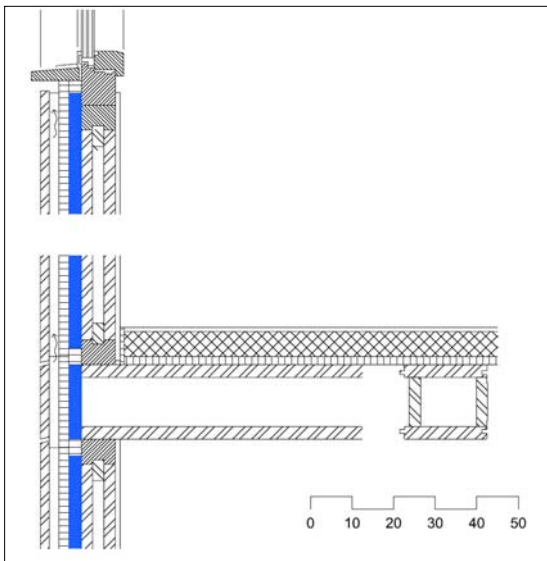

Figure 76: Tolerances in VIP integrated building components



5.3.2 Prefabricated wood construction system

Façade elements prefabricated in wood are a highly promising application area for VIP. Prefabrication in a woodworking factory takes place with high dimensional precision and under controlled conditions. For this reason, with proper planning, one can avoid the expensive matching pieces and tolerance zones that have to be filled when using conventional insulation. Furthermore, the risk of damage is minimized. Wherever possible, one should ensure that individual VIP or parts of the façade can be exchanged at a later point in time.



Wall structure

covering rear ventilated	
soft grain fibre board	24 mm
VIP	30 mm
three-layer board	27 mm
installation space (air)	27 mm
three-layer board	27 mm
gypsum plaster board	12 mm

Ceiling construction

parquet	10 mm
floor	65 mm
footfall insulation	20 mm
three-layer board	30 mm
cavity	119 mm
three-layer board	30 mm

Figure 77: Vertical section through the window and the support of the ceiling

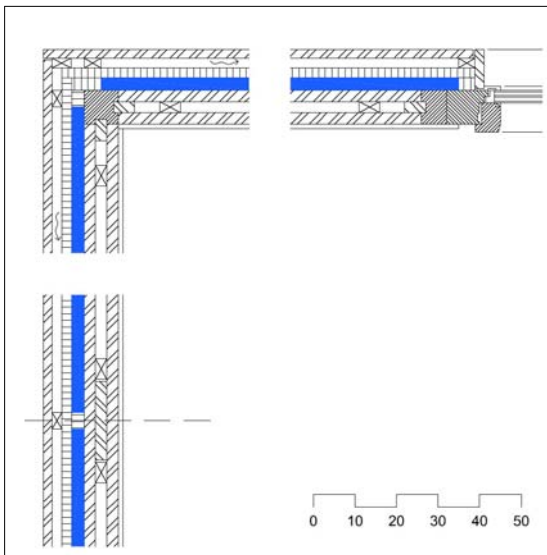

Wall structure

covering rear ventilated	
soft grain fibre board	24 mm
VIP	30 mm
three-layer board	27 mm
installation space (air)	27 mm
three-layer board	27 mm
gypsum plaster board	12 mm

Figure 78: Horizontal section through a joint of elements, edge and window



For a MFH project in Itingen (Switzerland), a wood construction system with integral VIP was developed. The rear-ventilated wall construction features a thin wall structure of 19 cm. This results in increased room space over a wall construction with conventional insulation. Figure 77 shows a vertical section, Figure 78 the plan of the construction.

The EMPA has investigated in detail the building physical of this construction and the results are documented in a component collection [4]. Figure 79 shows as an example the joint between the wood beam ceiling and the outer wall. Here one must pay attention to a vapour tight execution to avoid condensation (Figure 79, T 2). In the undisturbed region of the wall, the construction with a 2 cm VIP has a U-value of $0.28 \text{ W/m}^2\cdot\text{K}$, with 3 cm one of $0.23 \text{ W/m}^2\cdot\text{K}$. The calculations are based upon VIP of $100 \times 60 \text{ cm}$ with a lambda value of with $8 \cdot 10^{-3} \text{ W/m}^2\cdot\text{K}$ in the centre of the panel. The lathing between the VIP is taken into account.

The butt joint between the individual wood construction elements does not result in a problematic heat bridge. The investigations at the EMPA have shown that in the region of the lathing between the VIP, the temperature on the inner surface of the outer wall is 0.3 K lower than in the undisturbed region. Here too, one must pay attention to a vapour tight execution of the joints between the elements; otherwise, one must expect condensation to occur on the inside of the VIP when using 2 cm VIP.

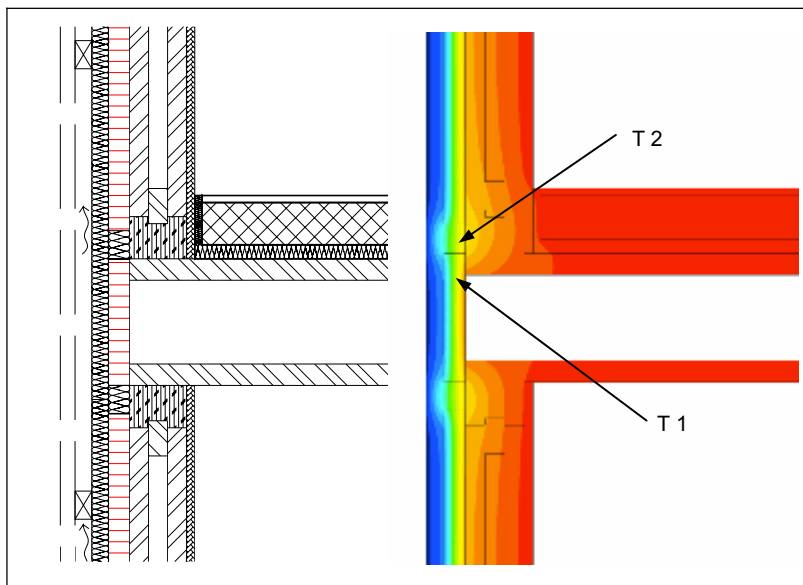

		VIP 20	VIP 30
T 1	min. VIP-surface	15.5 °C	16.2 °C
T 2	wood surface	10.5 °C	12.0 °C
f_{rsi}	site / value	T1 / 0.85	T1 / 0.87

Figure 79: Vertical section through a joint of elements, three-dimensional computational heatflow analysis and calculated temperatures



5.3.3 Dormer Window

In the course of modernization work on existing buildings, the creation of additional living space under the roof is often planned. Here, a dormer window will improve both the spacial situation and the illumination. Increasing requirements on building insulation demand a new approach in order to find satisfactory design solutions. Thanks to VIP, thin constructions may be realized.

The detail shows a prefabricated dormer window that is attached as a ready-made element to the cut-out prepared in the roof. This construction was developed and realized for the modernization of an old building (see Section 4.2). Owing to the two-layer, load-bearing design of the construction, one can dispense with lathing between the VIP, which further reduces the heat losses. Figure 80 shows the vertical section, Figure 81 the horizontal section of the construction.

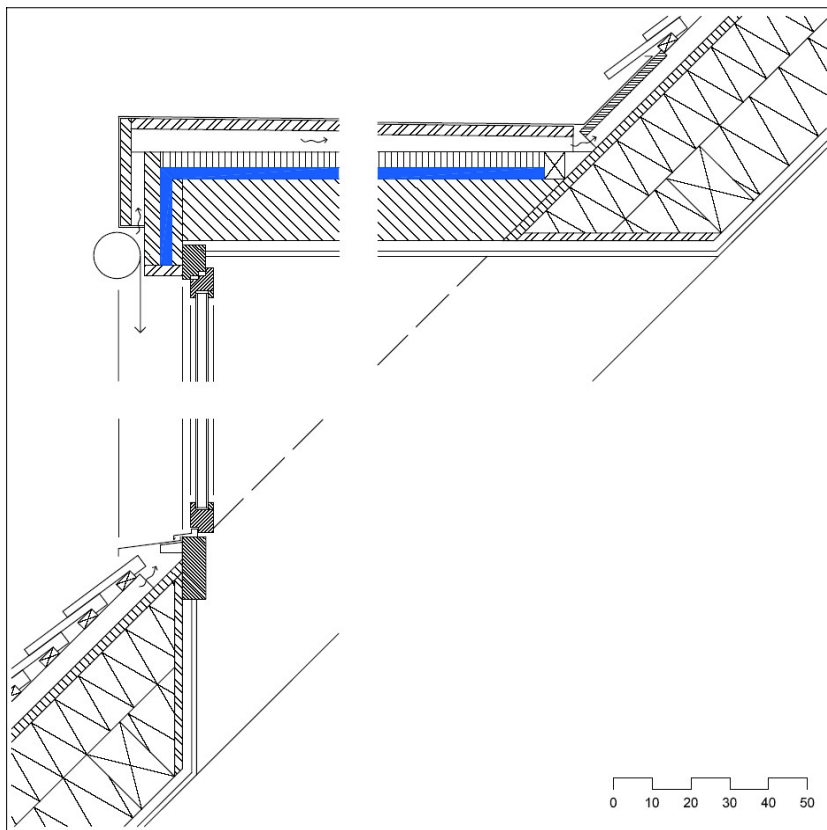

Roof structure

metal roofing	
roof sheeting	
three-layer board	27 mm
wooden laths	40-60 mm
protection mat	
soft grain board	40 mm
VIP	30 mm
ceiling (solid wood)	160 mm
vapour barrier	
wooden laths	27 mm
gypsum plaster board	12.5 mm

Figure 80: Vertical section through a prefabricated dormer window for the renovation of an old building

(Architect: Viridén + Partner, Zurich, Switzerland)

When installing sun shading and its guide rails, one must ensure that the adjacent VIP is not damaged by fixing screws.

The EMPA has investigated in detail the building physical of this construction and the results are documented in a component collection [4]. In the summer situation one must ensure that the temperature at the VIP surface does not rise too high. The additional insulation used (soft wood fibre board) lowers the surface temperature at this point significantly.

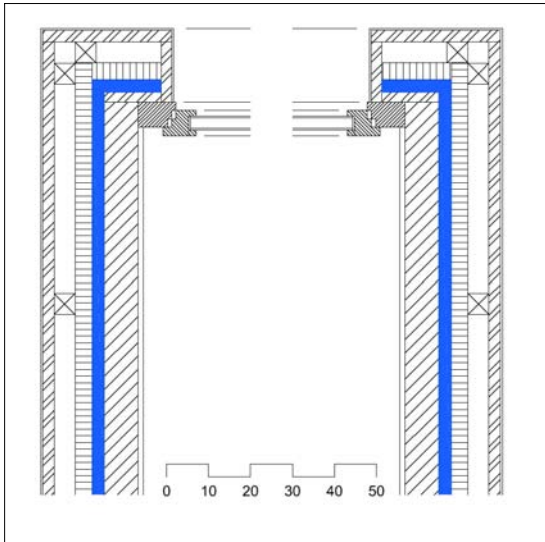

Wall structure

metal roofing	
roof sheeting	
three-layer board	27 mm
wooden laths	40-60 mm
protection mat	
soft grain board	40 mm
VIP	30 mm
wall (solid wood)	80 mm
vapour barrier	
wooden laths	27 mm
gypsum plaster board	12.5 mm

Figure 81: Horizontal section through a prefabricated dormer window for the renovation of an old building (Architect: Viridén + Partner, Zurich, Switzerland)

In order to decouple the window from movements of the roof, a dilatation gap was included between the load-bearing roof layer and the frame of the element. As shown by the isothermal images, one must expect condensation to occur at the dilatation gap (Figure 82, T1). To prevent this, a vapour barrier should be installed in front of the condensation plane to ensure that warm, moist indoor air cannot reach this point.

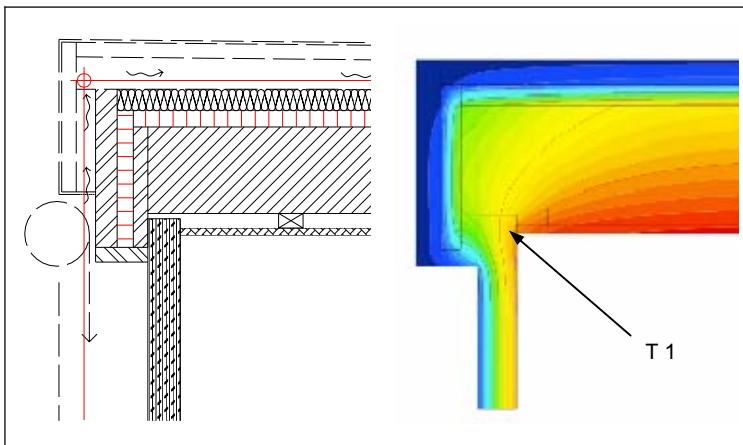

		VIP 20	VIP 30
T 1	min. surface	5.4 °C	5.9 °C
f _{rsi}	site / value	T1 / 0.51	T1 / 0.53

Figure 82: Vertical section through the dormer window, three-dimensional computational heatflow analysis and calculated temperatures.



5.3.4 Door panels

At the moment a Dutch door manufacturer, Kegro BV, is investigating the possibility of using vacuum insulation panels instead of polyurethane foam as thermal insulation in doors. Other door manufacturers, e.g. Brunegg AG (Brunex) in Switzerland, are working on or have already introduced VIP-doors as well.

The doors developed by Kegro BV in the Netherlands are mostly build up from hdf facings or facings that consist of an hdf-alu-hdf sandwich and a polyurethane core. The adhesion between the facings and the core foam makes sure that the door acts as a structural sandwich. A wooden frame, however, is added to the doors at the sides to create an aesthetically pleasing side, to give support to the door mountings and to add extra stiffness to the door. Mostly, a steel stabiliser is added at one side of the door panel to increase the door stiffness more and to prevent door warping. This stabiliser can have the following forms: a tube, a U-shape or two parallel strips. These stabilisers, however, cause an enormous cold bridge. At Delft University of Technology thermal calculations on door panels (Kegapro) with and without stabilisers have been performed [16].

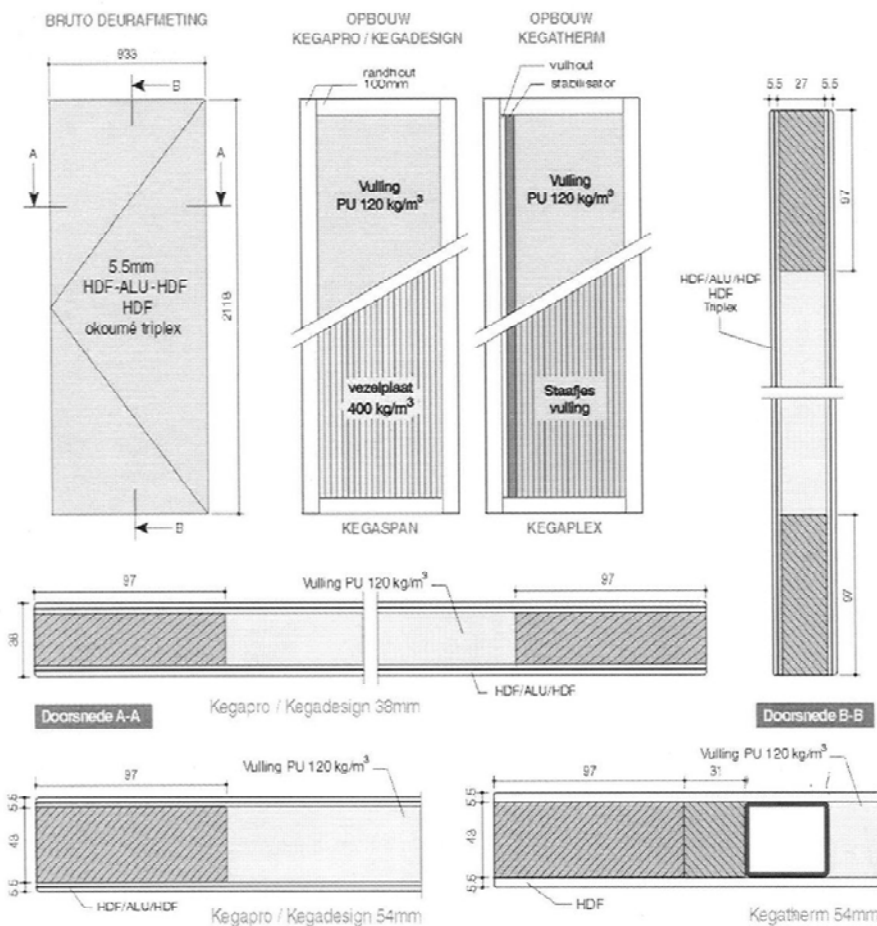

Figure 83: Overview of different door panel construction with polyurethane developed by Kegro BV in the Netherlands, source: Kegro BV



During the calculations the type of core material of the door was varied between polyurethane and vacuum insulation. The total thickness of the door was kept constant. Figure 83 shows some of the different door panel constructions. In the figure the core material depicted is polyurethane foam. Doors with a vacuum insulation core are more-or-less identical.

Thermal properties of doors

For the thermal calculations four different door variants were used: Kegapro door with a polyurethane core without a steel stabiliser, with a polyurethane core with a steel stabiliser, with a vacuum insulation core without a steel stabiliser, and with a vacuum insulation core with a steel stabiliser. Figure 84 shows the results of the calculations, conducted by van der Spoel [16], for the effective or overall U-value of a door panel with a thickness of 54 mm (without facing). As can be seen, the results quite distinctly show that replacing polyurethane foam by vacuum insulation leads to a reduction in U-value of 20% to 31%. This could be expected, because the thickness of the insulating layer is constant and the thermal conductivity of vacuum insulation is less than that of polyurethane. A second observation is that cold bridging due to the stabiliser is quite visible from the results as well (a reduction of 25% to 35% if no stabiliser is used). Some years ago therefore new ways of overcoming the panel-warping problem without steel stabilisers were sought. One expected solution was the introduction of a 0.3 or 0.5 mm thick aluminium plate in the facings on both sides of the door. This led to the introduction of the sandwich facing plate: hdf-alu-hdf. Practise and research, however, have shown that panel warping, which was not present in doors with a stabilising steel element, was a serious problem in doors with the new sandwich facings. New constructions to overcome the panel-warping problem are therefore required.

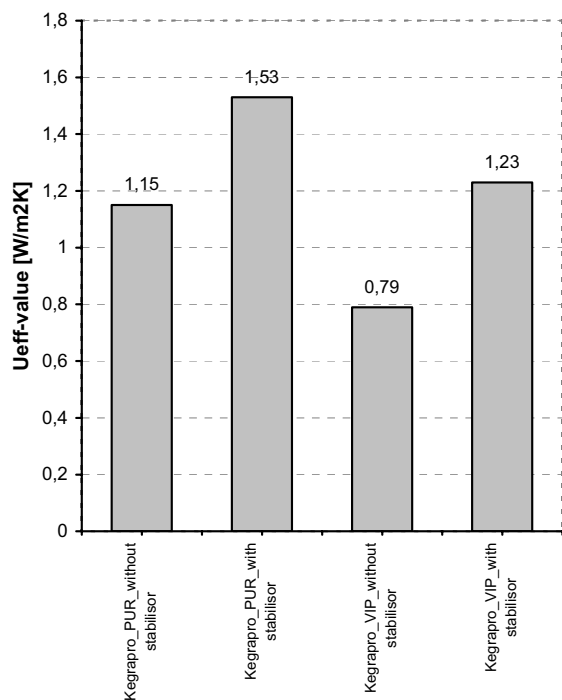

Figure 84: Effective U-value of Kegapro doors with different core materials and stabilisers



5.3.5 Low temperature floor and wall heating systems

An interesting application of VIP would be using them as a basis for thin low temperature floor or wall heating systems. The combination of high performance thermal insulation and low temperature floor heating can on the one hand increase primary energy and exergy savings and on the other hand create the condition for the application of sustainable energy systems in buildings [17].

Classification of and requirements for floor and wall heating systems

According to ISSO-publication 49 [19], floor and wall heating systems can be classified according to their thermal mass (Table 12). Each of these systems has its own specifics with regard to thermal, acoustical and building technical behaviour and requirements.

Table 12: Floor and wall heating classifications

construction type	floor heating system		wall heating system	
	floor thermal mass (kg/m ²)	floor classification	wall thermal mass (kg/m ³)	wall classification
Dry system	30-90	light weight	5-15	light weight
Wet system on top of insulation	170-240	medium weight	20-90	light weight
Wet system directly on top of structural floor or wall	ca. 300-700	heavy weight	200- ca.400	medium to heavy weight

Table 13: Advantages and disadvantages of different floor and wall heating systems

	light weight system	medium weight system	Heavy weight system
Advantage	<ul style="list-style-type: none"> * thin construction height * low weight * demountable * quick response * few processing steps 	<ul style="list-style-type: none"> * good thermal contact between ducts and wall/floor * good sound insulation 	<ul style="list-style-type: none"> * high loads on floor possible
Disadvantage	<ul style="list-style-type: none"> * bad sound insulation * clicking sounds 	<ul style="list-style-type: none"> * thick construction height * difficulties during demolishing * slow response time 	<ul style="list-style-type: none"> * very slow response time * no acoustical advantages * A screed layer of max. 30 mm is necessary if a quick response time is required

Some of these aspects are summarized in

Table 13, based on the before mentioned ISSO-publication. For vacuum insulation based floor heating systems it is important that the system can be classified as a dry system because of the possibility for replacing damaged panels in such systems. Wet systems would



have the disadvantage of more-or-less permanently enclosing the vacuum panel under a continuous non-removable layer.

The two principal requirements for the insulating layer in floor or wall heating systems can be identified as thermal insulation and acoustical insulation, the first of which, which is always necessary, is required to reduce energy losses and to increase the system controllability, the second of which, which is only necessary for dwelling separation walls and floors, is required to reduce acoustical transmissions. To specify performance criteria for these requirements a distinction must be made between the exact situations in which the system is applied. Performance criteria will therefore not be presented in this chapter.

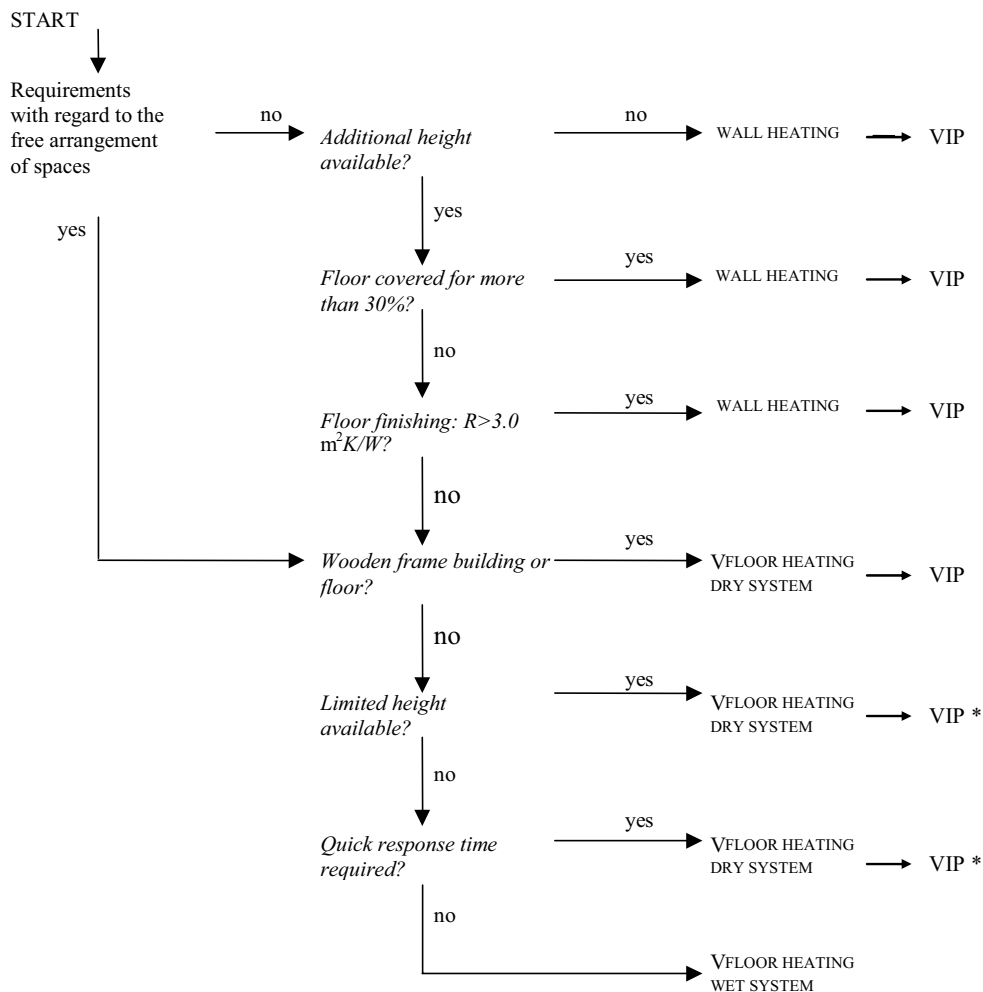

Figure 85: Decision model for low temperature heating systems

It is, however, important to notice that the thermal requirements for the insulator under a floor heating system specified in Building Codes are usually less strict than the requirement based upon thermal de-coupling of spaces. Thermal de-coupling is a measure to avoid that the space below a floor heating system is thermally influenced by this heating system. It is especially important for spaces under the floor heating system that have a lower temperature set point than the spaces above the heating system, for example a sleeping room with a temperature set point of 16 °C. This criterion conduces to a required thermal resistance, R , of



more than $2.0 \text{ m}^2\cdot\text{K}/\text{W}$, provided that the sum of thermal resistances of the material layers above the heating ducts are less than $0.13 \text{ m}^2\cdot\text{K}/\text{W}$ [20]. This criterion would thus support the use of VIP under heating systems on floors and walls not bordering outside air, as well.

The application possibilities for in floor or wall heating systems can be identified from Figure 85. As can be seen, VIP have a high potential for application in floor and wall heating systems, as long as the requirement of a dry system is fulfilled. Especially, the situations in which vacuum panels can give an added value are interesting. These VIP applications are marked with an asterisk (*) in the chart.

Recommendations

For a successful application of vacuum insulated low temperature floor (and wall) heating systems the following recommendations can be given:

Process

- Because of the specific properties of VIP, all participants in the building process need to be informed of the application of VIP and about the specifics of this product as soon as within the process possible preferably by a specialist.
- The users of the building in which a VIP based floor or wall heating system is applied need to be informed about what can and cannot be done related to the VIP products.

Design and manufacture

- Because of the sensitivity of VIP to damage, the structural layer needs to be as flat as possible and the panels need to have a protective layer between the panel and the structural floor or wall (and sometimes on the other side as well), which consist of a soft polymer foam layer (Ethafoam) of at least 3 mm thick, which smoothes for example the underlying construction layer.
- To prevent convective heat losses and water vapour diffusion through the seams between different VIP, these seams need to be tightly sealed with an aluminium tape.
- Because the service life of a VIP is influenced by the operating relative humidity of the surrounding air, or the presence of liquid water on top of the panel, the vacuum-insulating layer must be protected against water leakage from the heating system by a watertight layer, for instance a 0.2 mm thick polyethylene foil. These foils need to have an overlap of at least 80 mm and need to be sealed with tape. If a large water vapour flux is to be expected from within the construction layer a vapour closed foil (0.2 mm PE membrane) needs to be placed between structural (floor or wall) and insulating layer. In most cases this is, however, not necessary.
- From the perspective of VIP standardization and of taking up floor edge discontinuities resulting from doors, windows and structural elements, it is advised to fill the floor edges with conventional insulator materials or with defect VIP remainders; otherwise small series of irregularly shaped and possibly of too small dimensions are required.
- For a better distribution of heat over the floor surface area, slotted metal plates connected to the heating ducts can be applied for heat diffusion.
- To prevent high point loads that could damage the VIP, the top layer preferably should be able to diffuse loads, so that the area load on the VIP is reduced.



- Since the thermal aging behaviour of VIP amongst others depends on temperature – a higher temperature leads to an increased water vapour and gas permeation through the VIP high barrier envelope and thus to an increased thermal conductivity aging – the temperature of the water flowing through the heating ducts needs to be as low as possible. Low temperature systems are therefore preferred above high temperature systems. The maximum allowable water temperature in the heating ducts depends on the maximum required service life in combination with the type of VIP high barrier film and core material. Based on current knowledge, it is advisable to keep the maximum water temperature below 40 °C.

Installation

- Because VIP cannot be cut and reshaped on site, it is important to make a plan of the exact layout of the VIP before production is started.
- Since vacuum insulation has specific properties and is very sensitive to damage during transportation and installation, panels need to be installed (and transported) by qualified personnel only.

Acoustics

- Because of a probably high dynamic Young's modulus, the acoustical resonance frequency of vacuum insulation based floor heating systems might lie above 80 Hz, which will reduce the acoustical performance in the critical frequency regions of speech, music and traffic noise. Because, however, at the moment, not much information about the acoustical performance of VIP is available, it is advised to do acoustical field measurements after construction of the floor, at least if acoustical requirements are in place. A dynamic stiffness of the elastic layer needs to lie somewhere between 5 and 20 MN/m³.

Principle vacuum insulation floor heating constructions

A typical non-acoustical modern dry low temperature floor heating system consists of a construction height of approximately 55 mm, of which 35 mm Styrofoam insulation, at least if a thermal resistance of 1.0 m²·K/W is required. With vacuum insulation panel based low temperature floor heating systems smaller construction heights can be achieved, making these systems very attractive not only for newly constructed buildings but also for renovation projects.

Table 14: Theoretical construction heights for different insulator types in floor heating systems. For the construction height calculations a thermal conductivity of 0.035 and 0.007 W/(m·K) have been adopted. Besides, insulation thicknesses have not been adapted to commercial thicknesses.

thermal resistance	construction height	
	conventional construction	VIP construction
$R_{\text{insulation}} \geq 0.75 \text{ m}^2 \cdot \text{K/W}$	46 mm (26 mm Styrofoam)	31 mm (5 mm VIP)
$R_{\text{insulation}} \geq 1.00 \text{ m}^2 \cdot \text{K/W}$	55 mm (35 mm Styrofoam)	33 mm (7 mm VIP)
$R_{\text{insulation}} \geq 1.50 \text{ m}^2 \cdot \text{K/W}$	73 mm (53 mm Styrofoam)	37 mm (11 mm VIP)
$R_{\text{insulation}} \geq 2.00 \text{ m}^2 \cdot \text{K/W}$	90 mm (70 mm Styrofoam)	40 mm (14 mm VIP)



As can be seen from Table 14, the benefit of a reduced height is especially visible according as the required thermal resistance for the floor system increases. Since preferably insulation thermal resistances are higher than $2.0 \text{ m}^2\cdot\text{K}/\text{W}$ due to thermal de-coupling, vacuum insulation based floor heating systems have a high potential.

Two main categories VIP based floor and wall heating systems must be distinguished: acoustically active and acoustically non-active systems. The first type of system is a floor or wall heating system of which the acoustical properties are improved relative to the standard acoustically non-active VIP based floor or wall heating systems. Since, VIP probably have a dynamic stiffness of a magnitude of $\times 10^3 \text{ MN}/\text{m}^3$ resulting in a resonance frequency above 1000 Hz, acoustically non-active VIP based floor or wall heating systems would not perform very well in the critical frequency range of speech, music and traffic noise. A material with low dynamic stiffness, like mineral wool, needs to be added to the system for performance improvement.

Based on the recommendations from the previous section and based on the distinction between acoustically active and acoustically non-active systems, principle construction layouts can be designed for VIP based floor and wall heating systems. For the purpose of this chapter only examples of VIP based floor heating systems will be presented, assumed that low temperature wall heating systems follow the same principles. The proposed systems are based on a thermal resistance of the VIP insulation layer of more than $2.0 \text{ m}^2\cdot\text{K}/\text{W}$ and on the assumption that it is possible to make special VIP panels in which the heating ducts can be integrated. At this moment, the last assumption is probably not valid; it is, however, assumed that in the near future such preformed panels can be produced.

Figure 86 and Figure 87 show principle construction layouts of a dry VIP based acoustically non-active floor heating system in which the heating ducts are situated in the insulating layer (concept 1) or in the top layer (concept 2). With this system a construction height of 46 mm realizes an average thermal resistance of $2.5 \text{ m}^2\cdot\text{K}/\text{W}$ (concept 1) to $2.9 \text{ m}^2\cdot\text{K}/\text{W}$ (concept 2) of the insulating layer plus top layer and an estimated heat release of 100 to $120 \text{ W}/\text{m}^2$, at least for concept 1. Disadvantages of concept 1 are the small amount of insulating material below the heating pipes (6 mm), which has a thermal resistance of just $0.8 \text{ m}^2\cdot\text{K}/\text{W}$, or not enough to make thermal de-coupling possible and the risk of water penetration if one of the heating ducts is leaking.

Figure 88 and Figure 89 show a principle construction layout of an acoustically improved dry VIP based low temperature floor heating system in which the heating ducts are situated in the insulating layer (concept 1) or in the top layer (concept 2). This system leads to an increased construction thickness of in total 73 mm or, an average thermal resistance of $3.3 \text{ m}^2\cdot\text{K}/\text{W}$ and $3.7 \text{ m}^2\cdot\text{K}/\text{W}$ respectively, and of course an increased acoustical performance. To attune the resonance frequency of the floor construction on the acoustical requirements the thickness of the rock wool layer and the mass of the top layer can be changed. The total construction height of the acoustically improved concept is still less than the construction height of non-VIP based floor heating system.

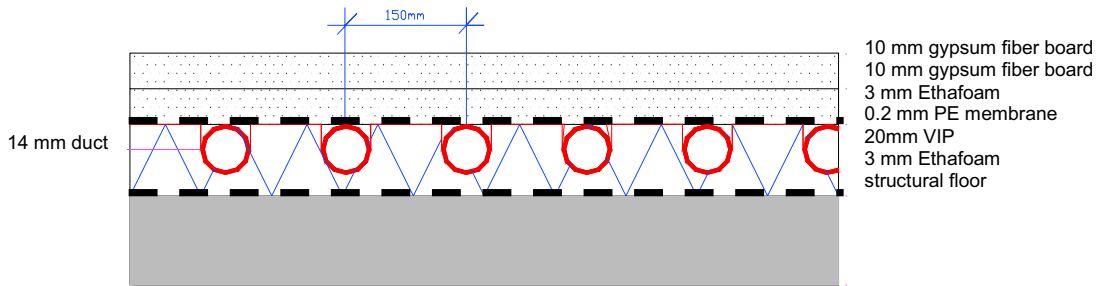

Figure 86: Principle construction layout of dry VIP based floor heating system (concept 1)

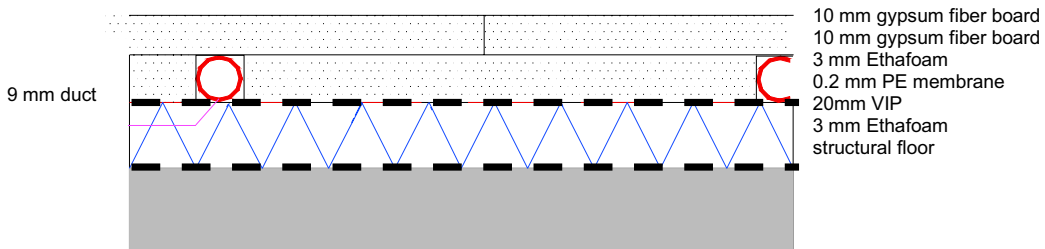

Figure 87: Principle construction layout of dry VIP based floor heating system (concept 2)

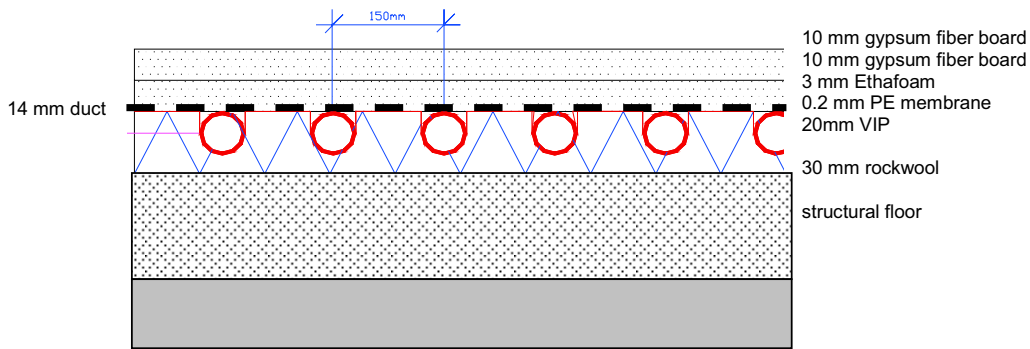

Figure 88: Principle construction layout of an acoustically improved dry VIP based floor heating system (concept 1)

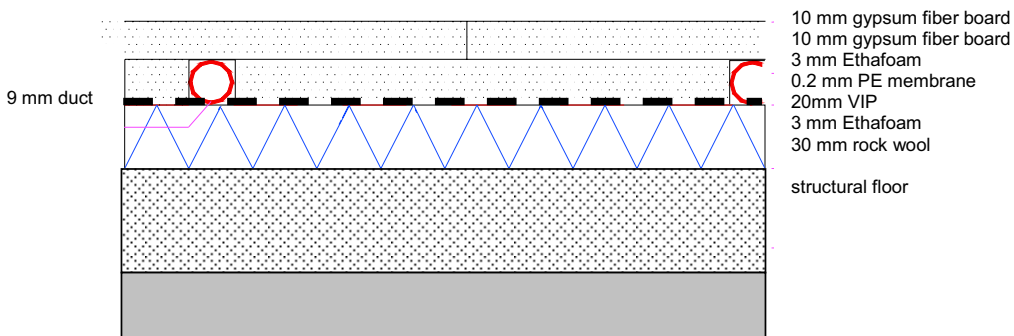

Figure 89: Principle construction layout of an acoustically improved dry VIP based floor heating system (concept 2)



6 Economic aspects

6.1 Costs

In making the choice of insulation material out of the multitude of products offered, the related additional benefits are of overriding importance. Apart from the required compression resistance, vapour permeability or tightness, moisture resistance, material ecology and service life, space requirements and hence the material-specific thermal transmission resistance become increasingly important. Insulation thickness around 16 cm in the case of standard new construction and thicknesses of up to ca. 40 cm in the case of passive houses may cause significant design problems, or even prejudice the type of construction in many cases (light instead of massive construction).

material	insulation-costs for d=100mm	thermal conductivity	costs per thermal transmission resistance
	e_{HI} [EUR/m ³]	λ [W/(m·K)]	$K_{R, spez}$ [EUR/m ² (m ² ·K/W)]
glass wool 16 kg/m ³	88.44	0.036	3.18
glass wool 40 kg/m ³	155.10	0.033	5.12
glass wool 70 kg/m ³	168.30	0.034	5.72
glass wool 80 kg/m ³	237.60	0.032	7.60
mineral wool 32 kg/m ³	80.52	0.036	2.90
mineral wool 50 kg/m ³	146.52	0.036	5.27
mineral wool 75 kg/m ³	174.90	0.036	6.30
mineral wool 100 kg/m ³	232.32	0.034	7.90
expanded polystyrene 20 kg/m ³	135.96	0.037	5.03
expanded polystyrene 30 kg/m ³	217.80	0.035	7.62
extruded polystyrene 33 kg/m ³	373.56	0.032	11.95
polyurethane 30 kg/m ³ mat-clad	262.02	0.028	7.34
polyurethane 30 kg/m ³ alu-clad	279.18	0.024	6.70
polyurethane sandwich panel	302.94	0.023	6.97
foam glass 130 kg/m ³	345.84	0.040	13.83
wood fibre insulation board 170 kg/m ³	221.10	0.040	8.84
cellulose insulation board, 70 kg/m ³	135.30	0.039	5.28
cork 120 kg/m ³	303.60	0.042	12.75
coco fibre insulation board 66 kg/m ³	198.00	0.045	8.91
VIP A	4'290.00	0.008	34.32
VIP B	4'290.00	0.005	21.45
	e [EUR/m ²]	U [W/m ² ·K]	[EUR/m ² (m ² ·K/W)]
glazing 2-IV	76.56	1.200	176.20

Figure 90: Specific costs of thermal insulation for various materials (price base: October 2004). The figures given are exclusive of installation and support structure.

VIP A: thermal conductivity $\lambda = 0.008$ W/(m·K), VIP B: $\lambda = 0.005$ W/(m·K)



Figure 90 shows the specific insulation costs of different insulation materials in comparison. The costs per unit of thermal transmission resistance vary considerably in dependence on the required additional benefits.

In the case of VIP we are dealing with a product that is still young and whose production procedures and distribution networks are not yet optimized. The evident differences in price illustrate this state of a market that is still transparent to a small extent. Depending on the panel size, the λ -value also changes significantly. This results in the situation that a comparison with conventional mass-produced insulation products has primarily an illustrative character. Nevertheless, the table shows that the relatively high material costs of the VIP may be partially compensated by the good insulation properties.

6.2 Economic benefits

By employing VIP in comparison with conventional insulation materials, building volume is saved. The thermal transmission resistance of VIP is higher by a factor of 3 to 6 and hence the required thickness is correspondingly lower.

This saving cannot be quantified everywhere (lower storey height when used under floor heating, stepless joints to the terrace, slim profiles at the edges of building components), but often only the application of VIP makes certain restoration and construction measures possible (savings in the restoration of flat roofs, façades, inside insulation). The present direction of product development is strongly towards applications in construction, which offer precisely this difficult to quantify space saving.

6.2.1 Savings in building land

With a low-energy single-family home, the volume of the insulation makes up almost 20-25% of the total heated building volume. Where the utilization factor is prescribed, the land area required for building increases correspondingly. As shown in Figure 91, the use of VIP can save land costs and the extra cost of the insulation can thus be covered to a large extent at least.

dimension of the building (heated volume, internal dimensions)																																																																															
width	b	[m]	8.00																																																																												
length	l	[m]	10.00																																																																												
height	h	[m]	5.10																																																																												
building area ratio	AR		0.25																																																																												
building site price	P	[EUR/m ²]	429.00																																																																												
thermal conductivity HI	λ_{HI}	[W/m·K]	0.036																																																																												
thermal conductivity VIP	λ_{VIP}	[W/m·K]	0.008																																																																												
				<table border="1"> <thead> <tr> <th colspan="2"></th> <th colspan="2"></th> <th>VIP</th> <th>HI</th> </tr> <tr> <th>insulation thickness</th> <th>d</th> <th>[m]</th> <td></td> <td>0.06</td> <td>0.27</td> </tr> </thead> <tbody> <tr> <td>heated volume (external dimensions)</td> <td>V_B</td> <td>[m³]</td> <td>428.95</td> <td>507.67</td> <td></td> </tr> <tr> <td>insulation volume</td> <td>V_{HI}</td> <td>[m³]</td> <td>20.95</td> <td>99.67</td> <td></td> </tr> <tr> <td></td> <td></td> <td>[%]</td> <td>5%</td> <td>20%</td> <td></td> </tr> <tr> <td>building area</td> <td>F</td> <td>[m²]</td> <td>82.17</td> <td>90.01</td> <td></td> </tr> <tr> <td>additional building area</td> <td>ΔF</td> <td>[m²]</td> <td></td> <td>7.84</td> <td></td> </tr> <tr> <td>building site</td> <td>A</td> <td>[m²]</td> <td>328.70</td> <td>360.05</td> <td></td> </tr> <tr> <td>additional building site</td> <td>ΔA</td> <td>[m²]</td> <td></td> <td>31.35</td> <td></td> </tr> <tr> <td>extra costs for building site</td> <td>C</td> <td>[EUR]</td> <td></td> <td>13'448.64</td> <td></td> </tr> <tr> <td>permissible extra costs</td> <td>$C_{per.}$</td> <td>[EUR/m³]</td> <td></td> <td>1'212.74</td> <td></td> </tr> <tr> <td></td> <td>$C_{per.}$</td> <td>[EUR/m²]</td> <td></td> <td>72.76</td> <td></td> </tr> </tbody> </table>								VIP	HI	insulation thickness	d	[m]		0.06	0.27	heated volume (external dimensions)	V_B	[m ³]	428.95	507.67		insulation volume	V_{HI}	[m ³]	20.95	99.67				[%]	5%	20%		building area	F	[m ²]	82.17	90.01		additional building area	ΔF	[m ²]		7.84		building site	A	[m ²]	328.70	360.05		additional building site	ΔA	[m ²]		31.35		extra costs for building site	C	[EUR]		13'448.64		permissible extra costs	$C_{per.}$	[EUR/m ³]		1'212.74			$C_{per.}$	[EUR/m ²]		72.76	
				VIP	HI																																																																										
insulation thickness	d	[m]		0.06	0.27																																																																										
heated volume (external dimensions)	V_B	[m ³]	428.95	507.67																																																																											
insulation volume	V_{HI}	[m ³]	20.95	99.67																																																																											
		[%]	5%	20%																																																																											
building area	F	[m ²]	82.17	90.01																																																																											
additional building area	ΔF	[m ²]		7.84																																																																											
building site	A	[m ²]	328.70	360.05																																																																											
additional building site	ΔA	[m ²]		31.35																																																																											
extra costs for building site	C	[EUR]		13'448.64																																																																											
permissible extra costs	$C_{per.}$	[EUR/m ³]		1'212.74																																																																											
	$C_{per.}$	[EUR/m ²]		72.76																																																																											

Figure 91: Insulation volume exemplified with a simple single-family home. Thanks to the use of VIP, a considerable saving in land area can be achieved. The extra material costs are thus covered to a large extent.



6.2.2 Maximization of usable area

If the land area for building is given or a restoration project requires inside insulation (townscape, listing as historic structure, minimum clear window size, etc.), then maximization of usable area in the construction or restoration project is of primary interest. If one now compares the costs of the usable area (or rental receipts) with the costs arising from the insulation action (material, loss of usable area), then the positive or negative value of the chosen insulation action may be assessed. The higher the costs of usable area in a property, the more interesting it becomes to employ space-saving VIP.

Figure 92 shows the permissible square metre and cubic metre costs of VIP, when its use can save area. Depending on the starting situation, we are dealing with expensive usable area that is saved (inside insulation), erection costs (new construction with not fully exploited land utilization) or at least the costs of the land for building. The calculations show that the VIP can be permitted to cost several times conventional insulation and still assert itself in the market as an economic alternative.

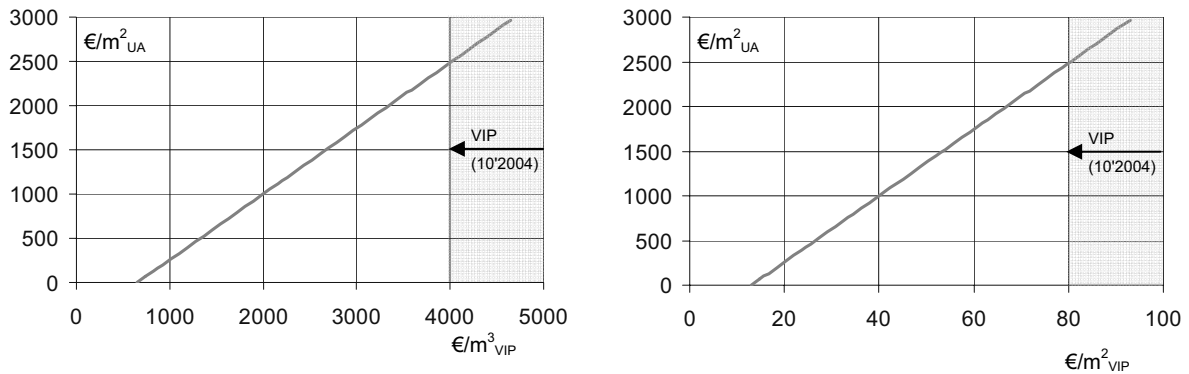

Figure 92: Permissible cubic metre (left) and square metre costs (right) of VIP as a function of the value of the saved usable area on the following assumptions: insulation layer 2 cm (VIP) instead of 9 cm (conventional insulation material), room height 2.6 m, 145 EUR/m³ conventional insulation material. 2 cm VIP > 4000 EUR/m³ and > 80 EUR/m² (price base: October 2004)



7 Annex 39 - Outlook

During this research program vacuum insulation has developed rapidly. At the beginning VIP was hardly known in the building branch and only a few pilot applications were realized. Only little was known concerning key questions as durability, gas tightness of envelope materials, behaviour under humid and hot conditions. Today it can be stated that VIP properties are well known and some important weaknesses have already been eliminated. We now have well documented experiences from the building site which have been implemented by the building industry for their VIP developments. The VIP production has been professionalized and the VIP have been better adapted to the needs of building applications.

Today we see a very broad interest in the VIP technology from the building branch and large number buildings in which VIP have been applied. But the quantitative wide use of vacuum insulation is still hindered by mainly two factors:

- high price
- lacking confidence in VIP technology and their use in building applications

Today cost

The work under the annex has shown that for the design of vacuum insulated constructions one may not use the thermal conductivity of VIP just after production of $\sim 0.004 \text{ W}/(\text{m}\cdot\text{K})$ but 0.006 to $0.008 \text{ W}/(\text{m}\cdot\text{K})$. Hereby the already high material cost rise to a level which hinders strongly the mass use. Even when gains by space savings and constructional simplifications are considered, the resulting costs are hardly acceptable for standard insulation applications. Unfortunately today just little advantage is taken of the regained liberty to develop low U-value building parts with new slim designs. VIP is mainly used in special applications where further advantages are obtained. In renovations by the use of VIP, additional expenses can be avoided, as for instance the lengthening of the roof when insulating the façade. Often VIP is used as a problem solver, e.g. for terrace insulation, VIP is here the only possibility to prevent a step between the heated room and the terrace.

That today the rather crucial direct use of unprotected panels has become the common practice on building sites, has its reason probably also in the high VIP prices. Only very innovative producers of prefabricated insulated building parts (sandwich panels, doors, façade systems etc.) do invest in the new technology. Many others hesitate because they assess VIP as too expensive to be used in their products.

Cost reduction potentials

To achieve a distinct higher market share it is absolutely necessary that VIP prices come down. To estimate how and to what extent price reductions are possible, it would be interesting to know the main cost factors for VIP production. Unfortunately we only have limited information on that topic. For example, it is known that the materials (core and envelope materials) represent quite a high portion of the total cost. With the envelope materials, it can be assumed that it is mainly the production quantity which defines the price. However, fumed



silica is already a mass product. Physically it seems to be possible to reduce the portion of fumed silica in the board or to replace it with a cheaper material (e.g. organic foam). In particular the latter requires tighter films to maintain a lower pressure in the panel. Such high barrier films are not only needed for VIP with other core materials but also for (building) applications in more humid / hotter environments. This kind of extreme high barrier film is also developed for other applications (e.g. OLED) which have similar demands. It is therefore quite probable that they will be available soon.

Furthermore the production of VIP is still dominated by expensive manual work. But the portion of the automated production steps has increased in the last years. This development must lead to a price reduction in the near future.

For the next five to ten years, it can be assumed that VIP solutions will remain more expensive than conventional constructions with the same U-value. This is also caused by the fact that conventional insulations are being improved.

Quality assurance

Annex 39 has also contributed to increased confidence in VIP. For instance it was shown that the environment in the main building applications allow a VIP service life of 50 years and more.

Actions are needed in the field of quality assurance. It has to be made sure that the VIP applied in a building do not get damaged during handling and installation processes. Through systematic measurements of the internal pressure of the panels, defective specimens can be tracked down and crucial processes identified. The today available measurement technology is only partially suitable for quality control of the whole process chain. Ongoing developments lead to the conclusion that in the near future a cheaper and more easily applicable measurement device will be available.

Official certification

Another obstacle are missing product approvals for VIP and VIP based systems for buildings.



8 Supplier Addresses

VIP suppliers involved in the projects documented in section 4
(alphabetical order)

lambdasave GmbH
Ekkehard Nowara
Am Duckeldamm
26725 Emden / Germany
Tel.: +49 (4921) 9768 00
E-mail: nowara@lambdasave.com
Internet: <http://www.lambdasave.de>

microtherm international LTD
Industriepark Noord 1
9100 Sint-Niklaas / Belgium
Tel.: +32 (3) 760 1980
E-mail: marc.vanhoeyland@microtherm.be
Internet: <http://www.microtherm.uk.com>

microtherm germany
Josef Kloo
Rosenstr. 4
83052 Bruckmühl / Germany
Tel.: +49 (8062) 4635
E-mail: josefkloo@aol.com
Internet: <http://www.microtherm.uk.com>

Porextherm Dämmstoffe GmbH
Gregor Erbenich
Müller-Thurgau-Str. 3
65366 Geisenheim / Germany
Tel.: +49 (6722) 750 150
E-mail: gregor.erbenich@porextherm.com
Internet: <http://www.porextherm.com>

SAES Getters GmbH
Stephan Paetz
Gerolsteiner Str.1
50937 Koeln / Germany
Tel.: +49 (221) 944075 15
E-mail: stephan_paetz@saes-group.com
Internet: <http://www.saesgetters.com/default.aspx?idPage=131>

Wacker Chemie AG
Business segment thermal insulation was taken over by
Porextherm Dämmstoffe GmbH
(1.11.2004)

va-Q-tec AG
Dr. Roland Caps
Karl-Ferdinand-Braun-Str. 7
97080 Würzburg / Germany
Tel.: +49 (931) 35942 0
E-mail: info@va-Q-tec.com
Internet: <http://www.va-q-tec.de>



References

- [1] Ghazi Wakili, K., R. Bundi and B. Binder (2004). 'Effective Thermal Conductivity of Vacuum Insulation panels.', *Building Research and Information* 32(4) p. 293-299, UK.
- [2] Cauberg, J.J.M. and M.J. Tenpierik (2004). 'An Approximating Model for Calculating Thermal Bridge Effects of Aluminium Based Thin Foil High Barrier Envelopes around Vacuum Insulation Panels.', paper in the framework of the IEA/ECBCS Annex 39 HiPTI-project.
- [3] Källebrink, I. (2004). 'High Performance Vacuum Insulation in Building Applications.', master thesis, Swedish, KTH - School of Architectural and Built Environment - Division of Building Technology, Sweden.
- [4] Ghazi Wakili, K., R. Bundi and A. Binz (2005). 'Building constructions with integrated vacuum insulation panels – calculated thermal bridge effects.', paper in the framework of the IEA/ECBCS Annex 39 HiPTI-project.
- [5] Simmler, H. and Brunner, S. (2005). 'Vacuum insulation panels for building application: Basic properties, aging mechanisms and service life.', accepted for publication in *Energy & Buildings*.
- [6] Erb, M. (ed.) (2005). 'Vacuum Insulation Panels - Study on VIP-components and Panels for Service Life Prediction of VIP in Building Applications ', IEA/ECBCS Annex 39 report (Subtask A).
- [7] e.g. EN 13165: 'Thermal insulation products for buildings - Factory made rigid polyurethane foam (PUR) products.'
- [8] Goedkoop, Spruiensma (2000). 'The Eco-indicator 99.', *Methodology Report April 2000, 2nd Edition*, NL.
- [9] Bundesamt für Umwelt, Wald und Landschaft (1998). 'Bewertung in Ökobilanzen mit der Methode der ökologischen Knappheit.', *Schriftenreihe Umwelt N. 297, Ökobilanzen*, CH.
- [10] Bundesamt für Umwelt, Wald und Landschaft (1999). 'Ökologische Bewertung mit Hilfe der Grauen Energie.', *Schriftenreihe Umwelt N. 307, Ökobilanzen*, CH.
- [11] Bundesamt für Energiewirtschaft (1996). 'Ökoinventare von Energiesystemen.', 3. Auflage, ENET, CH.
- [12] ESU-services, R. Frischknecht (2001). *firmeneigene Datenbanken mit Inventardaten von Prozessen und Produkten*, CH.
- [13] Weibel, Stritz (1995). 'Ökoinventare und Wirkungsbilanzen von Baumaterialien.', *Grundlagen für den ökologischen Vergleich von Hochbaukonstruktionen*, Zürich, CH.
- [14] Richter et al. (1995). 'Energie- und Stoffbilanzen bei der Herstellung von Wärmedämmstoffen.', Dübendorf, CH.



- [15] Schonhardt, U. et al. (2003). 'Oekobilanz eines Vakuum-Isolations-Panels (VIP).', 68p., German, University of Applied Sciences, Institute of Energy, Basel, CH.
- [16] Spoel, W.H. van der (2003). 'Memo: Warmtedoorgang door deuren met/zonder vacuum insulation panel-paneel.', Department of Civil Engineering TUDelft, 3 pages.
- [17] Cauberg, J.J.M., E.J.A. van Roijen and M.J. Tenpierik. Research conducted at Cauberg-Huygen Consulting Engineers Maastricht by ing. E.J.A. Roijen commissioned by contracting firm Panegro B.V.
- [18] Gregorio, P. Di, E. Rizzi, and M. Urbano (2001). 'Improved Vacuum Insulated Panel Design for Water Heaters.', 5th Annual Vacuum Insulation Symposium, May 2001.
- [19] ISSO (2002). 'Vloer- en wandverwarming.', ISSO Publication 49.
- [20] Roijen, E.J.A. (2004). 'Report 2003.1665-1: Toepassingsmogelijkheden van Vacuüm Isolatie Panelen bij LTV vloer- en wandverwarmingssystemen in woningen.', research report Cauberg-Huygen Consulting Engineers Maastricht.
- [21] Zoughaib, A. (2002). 'Adopting VIP in Appliances: the Water Heater Case.', VIA symposium presentations 2002.